



# Getting Started with DraftSight™



©2010 Dassault Systèmes, All Rights Reserved  
DraftSight and the DraftSight logos are trademarks of Dassault Systèmes or its subsidiaries in the US and/or other countries. Other brand or product names are trademarks or registered trademarks of their respective holders.

The information and the software discussed in this document are subject to change without notice and are not commitments by Dassault Systemes or its subsidiaries.

No material may be reproduced or transmitted in any form or by any means, electronic or mechanical, for any purpose without the express written permission of Dassault Systèmes or its subsidiaries.

The software discussed in this document is furnished under a license and may be used or copied only in accordance with the terms of this license. Nothing stated in, or implied by, this document or its contents shall be considered or deemed a modification or amendment of any warranties set forth in the terms of the software license agreement.

COMMERCIAL COMPUTER  
SOFTWARE - PROPRIETARY

U.S. Government Restricted Rights. Use, duplication, or disclosure by the government is subject to restrictions as set forth in FAR 52.227-19 (Commercial Computer Software - Restricted Rights), DFARS 227.7202 (Commercial Computer Software - Restricted Rights), DFARS 227.7202 (Commercial Computer Software and Commercial Computer Software Documentation), and in the license agreement, as applicable.

Contractor/Manufacturer:  
Dassault Systèmes  
10, rue Marcel Dassault  
78140 Velizy-Villacoublay  
France

Part Number: PMT1080-ENG Rev. 1



## CONTENTS

## INTRODUCTION

Using this Book .....	2
What is DraftSight? .....	2
Conventions Used in this Book .....	2
Start a DraftSight Session .....	3
DraftSight User Interface .....	4
Main Menu .....	4
Drop-down Menu .....	4
Context Menu .....	4
Keyboard Shortcuts .....	5
Standard Toolbar .....	5
Graphics Area .....	6
View Tiles .....	6
Graphics Cursor / Crosshairs .....	7
Cartesian Coordinate System / Origin .....	7
Coordinate System .....	7
Model Tab and Sheet Tab .....	8
Command Window .....	9
Status Bar .....	10
Palettes .....	11
Zoom Commands .....	12
Draw Toolbar .....	13
Modify Toolbar .....	14
EntitySnap Toolbar .....	15
Layers Toolbar .....	16
Layer Tools Toolbar .....	16
Properties Toolbar .....	17
Mouse Buttons .....	18
Cancel or End Command .....	18
Help .....	19
Manipulating Toolbars .....	19
Move .....	19
Display .....	19

## Lesson 1: QUICK START

Quick Start . . . . .	22
Start a DraftSight Session. . . . .	22
Creating a New Drawing . . . . .	22
Drawing Template. . . . .	22
Set the Drawing Environment. . . . .	23
Set Drawing Unit System . . . . .	23
Set Drawing Boundary . . . . .	24
Set Snap and Grid . . . . .	25
Zoom Bounds . . . . .	26
Line Command. . . . .	27
Open an Existing Drawing . . . . .	31
Delete Command . . . . .	31
Single Entity . . . . .	31
Arc Command. . . . .	32
Circle Command . . . . .	33
Entity Selection . . . . .	36
Window Select . . . . .	36
Crossing Select. . . . .	37
Delete Command . . . . .	37
Multiple Entities. . . . .	37
Move Command. . . . .	38
Multiple Entites . . . . .	38
Single Entity. . . . .	39
Creating a New Drawing . . . . .	40
Drawing Template. . . . .	41
Set the Drawing Environment. . . . .	41
Set Drawing Unit System . . . . .	41
Set Drawing Boundary . . . . .	42
Set Snap and Grid . . . . .	44
Zoom Bounds . . . . .	45
Absolute and Relative Coordinates. . . . .	45
Absolute Coordinates . . . . .	46
Relative Coordinates . . . . .	46
Entering Keyboard Input . . . . .	46
Draw a Rectangle Using Absolute Coordinates . . . . .	47
Draw the Second Shape Using Relative Coordinates . . . . .	49
Draw the Third Shape Using Relative and Absolute Coordinates. . . . .	50
Print Command . . . . .	51
Model Tab / Sheet Tabs . . . . .	52
Pan Commands . . . . .	54
Correct Drafting Mistakes . . . . .	56



## Lesson 2: DRAFTING TUTORIALS

Drafting Tutorials . . . . .	58
Start a DraftSight Session. . . . .	59
Create a New Drawing . . . . .	59
Drawing Template. . . . .	59
Set the Drawing Environment. . . . .	59
Drawing Unit System . . . . .	59
Drawing Boundary . . . . .	60
Set Snap and Grid . . . . .	60
Zoom Bounds . . . . .	60
Working with Layers . . . . .	61
Layer 0: The Default Layer . . . . .	61
Layer Properties . . . . .	61
Manage Layers. . . . .	63
Creating New Layers. . . . .	63
Changing the Active Layer. . . . .	63
Renaming a Layer . . . . .	64
Controlling Layer Behavior . . . . .	64
Setting the LineColor . . . . .	64
Setting the Layer LineStyle . . . . .	64
Setting a Layer LineWeight. . . . .	65
Setting PrintStyle. . . . .	65
Setting Print . . . . .	66
Setting Description . . . . .	66
Setting Filtering and Display Options . . . . .	66
Create Three New Layers for the Drawing. . . . .	66
Create the First New Drawing. . . . .	72
Draw a Circle . . . . .	72
Draw a Hexagon . . . . .	73
Copy Command . . . . .	74
Modify the Diameter of the Copied Circle . . . . .	75
Draw Two Parallel and Horizontal Lines. . . . .	75
Trim Command . . . . .	76
Fillet Command . . . . .	77
Mirror Command. . . . .	79
Rotate Command. . . . .	80
Trim Command . . . . .	81
Draw Entities on the Centerline Layer. . . . .	83
Rectangle Command. . . . .	84
SimpleNote Command . . . . .	84
Draw a Spline on the Construction Layer. . . . .	85
Spline Command . . . . .	86
PolyLine Command. . . . .	88
Edit PolyLine Command. . . . .	90
Modify the PolyLine Width . . . . .	90

Return and Activate the Object Layer.....	91
Create a Second New Drawing .....	92
Drawing Template.....	92
Set the Drawing Environment.....	92
Drawing Unit System .....	92
Set Drawing Boundary .....	93
Set Snap and Grid .....	93
Zoom Bounds .....	93
Create New Layers for the Drawing.....	94
Create the Second Drawing.....	99
Rectangle Command.....	99
Pattern Command: Linear Option.....	100
Chamfer Command.....	101
Pattern Command: Circular Option .....	103
Create the Third New Drawing.....	104
Drawing Template.....	105
Set the Drawing Environment.....	105
Drawing Unit System .....	105
Set Drawing Boundary .....	105
Set Snap and Grid .....	106
Zoom Bounds .....	106
Create New Layers for the Drawing.....	106
Construct a Circle from Two Tangent Circles and the Radius	108
Offset Command .....	110
Pattern Command: Circular Option .....	112

### Lesson 3: BASIC DIMENSIONING

Basic Dimensioning . . . . .	116
Start a DraftSight Session . . . . .	118
Dimension Toolbar . . . . .	118
Display the Dimension Toolbar . . . . .	118
Dimension Terminology . . . . .	121
Dimension Line . . . . .	121
Arrow . . . . .	121
Extension Line . . . . .	121
Dimension Text . . . . .	121
Leader . . . . .	121
Center Mark . . . . .	121
Open an Existing Drawing . . . . .	121
Create a New Layer . . . . .	122
Working with Dimensions . . . . .	123
Dimension Styles Manager Dialog Box . . . . .	123
DimensionStyle Command . . . . .	123
Linear Command . . . . .	124
Create Two Linear Dimensions . . . . .	125
Modify Dimension Precision Display . . . . .	126
Angular Command . . . . .	128
Create an Angular Dimension . . . . .	128
Aligned Command . . . . .	129
Create an Aligned Dimension . . . . .	129
Edit Dimensions and Dimension Text . . . . .	129
DimensionEdit Command . . . . .	130
DimensionTextEdit Command . . . . .	130
Dimension Text Alignment Options . . . . .	130
Modify the Linear Dimension Text . . . . .	130
Measure and Rotate an Aligned Dimension . . . . .	131
Move Command . . . . .	133
Coordinate System Command . . . . .	134
Ordinate Command . . . . .	135
Create Ordinate Dimensions . . . . .	135
CenterMarks Command . . . . .	136
Open an Existing Drawing . . . . .	137
Create a New Layer . . . . .	137
DimensionStyle Command . . . . .	137
Modify the Default CenterMark Size . . . . .	138
Create a Pattern of CenterMarks . . . . .	139
Radius Command . . . . .	141

**Lesson 4:  
DRAFTING APPLICATION**

Drafting Application . . . . .	146
Start a DraftSight Session. . . . .	149
Create a New Drawing . . . . .	149
Set the Drawing Environment . . . . .	149
Drawing Template . . . . .	149
Drawing Unit System . . . . .	150
Drawing Boundary . . . . .	150
Set Snap and Grid . . . . .	150
Create two new Layers for the drawing . . . . .	151
Draw a capacitor symbol . . . . .	152
Note Command . . . . .	153
Blocks . . . . .	154
Draw a Simple Schematic. . . . .	156
Ring Command. . . . .	160
Explode a Block . . . . .	161
Create a New Drawing . . . . .	162
Set the Drawing Environment . . . . .	162
Drawing Template . . . . .	162
Drawing Unit System . . . . .	163
Drawing Boundary . . . . .	163
Set Snap and Grid . . . . .	163
Create Six New Layers . . . . .	164
Draw Three Profiles. . . . .	168
Hatch Command . . . . .	172
Dimension the Views . . . . .	173
Dimension Commands . . . . .	174
Linear Command . . . . .	174
Create Linear Dimensions . . . . .	174
Apply the Tolerance . . . . .	176

## INTRODUCTION

When you complete this lesson, you will be able to:

- Understand the basic capabilities of DraftSight.
- Start a DraftSight session.
- Identify the principal components of the DraftSight user interface.
- Identify the graphics area, layout tabs, command window, command prompt, and status bar.
- Identify the default toolbars in the user interface: Main Menu, Standard, Draw, Modify, Layer, Properties and Entity Snap.
- Understand the use of the default Palettes.
- Manipulate toolbars by moving them and turning them on and off.

## Using this Book

This book is designed to be used by the learner alone, without the aid of an instructor. This is a basic training guide for new DraftSight users. It is designed for users with little or no CAD experience.

This guide will cover the fundamental skills necessary for efficient use of DraftSight and will provide a strong foundation for advancement.

Experienced users may also benefit from using this guide by understanding the menu system and dialog used by DraftSight.

This guide is organized in a chronological manner that will allow you to build on your knowledge as you progress through the course.

## What is DraftSight?

DraftSight is a drafting automation software tool. A coordinate system determines each point of a drawing surface or entity unambiguously. DraftSight uses the Cartesian coordinate system consisting of three coordinate axes. Axes are arranged orthogonally, crossing at the origin. All axes use the same unit of measurements.

## Conventions Used in this Book

This manual uses the following typographical conventions:

Convention	Meaning
<b>17 Click Line.</b>	The steps in the lessons are numbered in sans serif bold.
<b>Bold</b>	DraftSight commands and tools appear in this style. For example, Clicking the <b>Line</b> icon  means choose the <b>Line</b> tool on the Draw toolbar.
↵	The ↵ symbol means press the <b>Enter</b> key on the keyboard.
Command prompt	Prompts and information in the command window and Command prompt are displayed in this font. For example: Speci fy next poi nt»
<b>Bold</b>	Information you type into the command window appears in this font. For example: Speci fy next poi nt» <b>200,100</b> ↵
Typewriter	File names are in this font. For example, Lesson 1-1

## Start a DraftSight Session



### 1 Start a DraftSight session.

From the Windows Start menu, click **Start, All Programs, Dassault Systemes, DraftSight**.

#### TIP:

If you created the DraftSight icon on your desktop, double-click the icon to start a DraftSight session.

DraftSight automatically assigns a generic name, **NONAME\_0.dwg** to a new drawing. Each subsequent file that is open assigns another name by increasing the numeric value by 1.

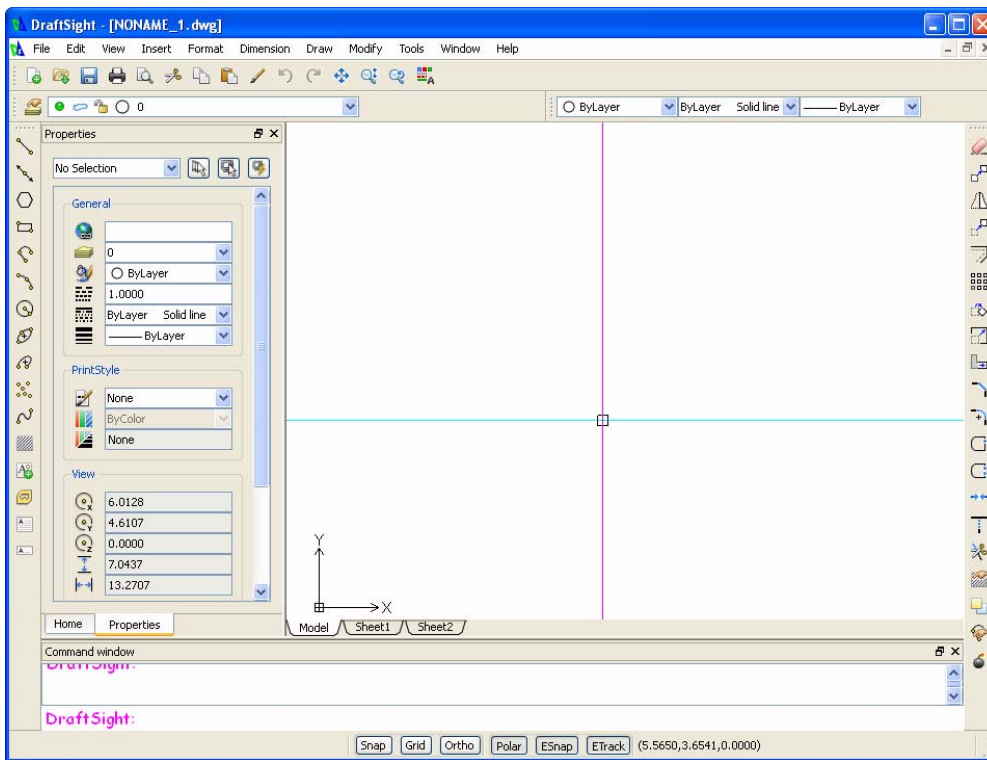

#### NOTE:

Scroll bars may be added to the right and bottom margins on the graphics area to pan the drawing view.

### DraftSight User Interface

The default DraftSight drawing screen contains the Main Menu, Standard toolbar, Modify toolbar, Draw toolbar, Layers toolbar, Properties toolbar, the Graphics area, command window, Status bar, and Tool Palettes.

Tool tips appear on each icon as you move the mouse cursor over the icon. You can resize the graphics area by click and drag at the edges of the window, or by resizing or closing the Tool Palettes, default toolbars, or command window.

### Main Menu

The Main Menu is displayed by default. The default menu items for an active drawing document are: **File, Edit, View, Insert, Format, Dimension, Draw, Modify, Tools, Window, and Help.**

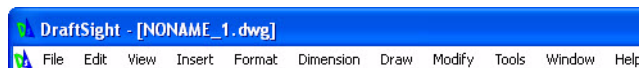

**NOTE:** Menu content varies depending on the menu file that is loaded - The standard menu or individualized menus.

### Drop-down Menu

Drop-down menus are available from the Main Menu at the top of the screen. To select any of the available commands, move your cursor over an item and click. Commands followed by a black arrow will display an additional list of related options.

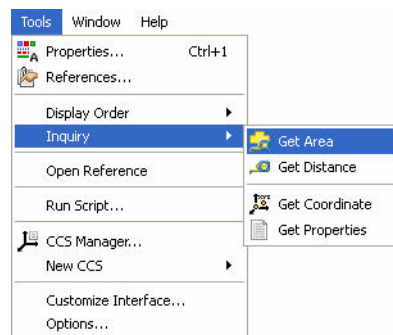

### Context Menu

Right-click in the graphics area displays a Context Menu. The Context Menu remembers your last command. If no command is active, the Context Menu displays commonly used commands.

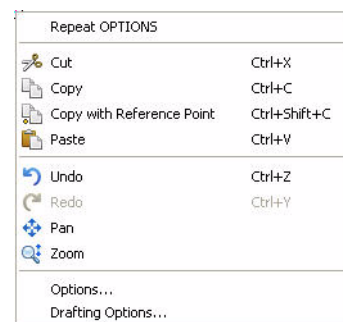



## Keyboard Shortcuts

Some menu items indicate a keyboard shortcut like this:

 Cut Ctrl+X

DraftSightDraftSight conforms to default Windows conventions for shortcuts such as:

- **Ctrl+O** for **File Open**
- **Ctrl+S** for **File, Save**
- **Ctrl+X** for **Cut**
- **Ctrl+C** for **Copy**

In addition, you can customize DraftSight by creating your own shortcuts.

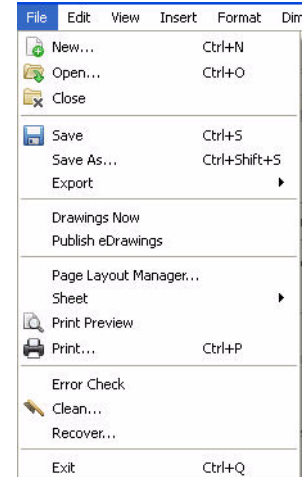















## Standard Toolbar



Toolbars contain groups of related command icons for quick access. The Standard toolbar is located (docked) beneath the Menu bar. The Standard toolbar allows you to quickly access the most frequently used commands. You can customize the toolbar by adding or removing icons.

The available default tools on the Standard toolbar are:

-  **New**: Creates a new drawing file.
-  **Open**: Opens an existing drawing file.
-  **Save**: Saves the drawing file.
-  **Print**: Prints a drawing to a plotter, printer or file.
-  **Print Preview**: Shows how the drawing will look when it is printed or plotted.
-  **Cut**: Copies entities to the Windows Clipboard and removes the entities from the drawing.
-  **Copy**: Copies entities to the Windows Clipboard.
-  **Paste**: Inserts data from the Windows Clipboard.
-  **Property Painter**: Applies the properties of a selected entity to other entities.
-  **Undo**: Reverses the most recent action.
-  **Redo**: Reverses the effects of the previous **Undo** or **U** command.
-  **Dynamic Pan**: Moves the view in the ViewPort.
-  **Dynamic Zoom**: Zooms to increase or decreases the apparent size of entities in the ViewPort.
-  **Zoom Previous**: Zooms to display previous view.
-  **Properties**: Controls properties of existing entities.

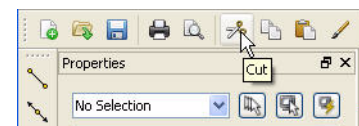

### TIP:

Hold the mouse pointer over an icon momentarily, and a tool tip appears describing the icon.

## Graphics Area

The graphics area is the part of the desktop where drawing entities are created and modified. Multiple drawings can be opened simultaneously.

Each drawing and each view is represented in its own window. The individual windows can be tiled, cascaded, or enlarged to fill the graphics area.

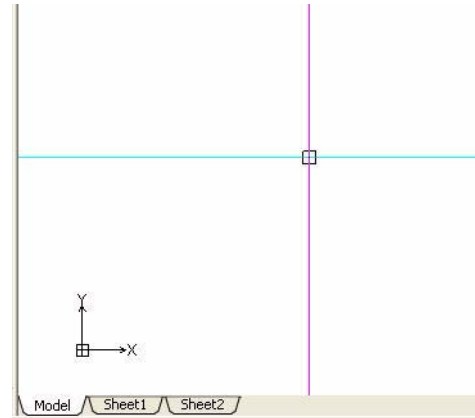

### NOTE:

For clarity, the graphics area in this book is displayed in white. Default colors can be modified from **Tools, Options, System Options, Element Colors** from the Main Menu

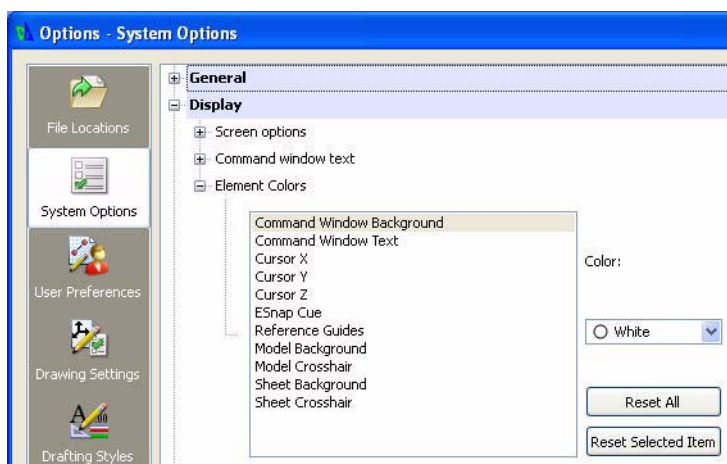

## View Tiles

The **View Tiles** command divides the graphics area into multiple windows. Each tile can contain a unique view of the drawing. This enables you to view different areas of the drawing, whether they are plan views in different detailing grades, or the model from different view points. You can work in only one window at a time, the current window.

Click **View, View Titles** from the Main Menu to view your options.

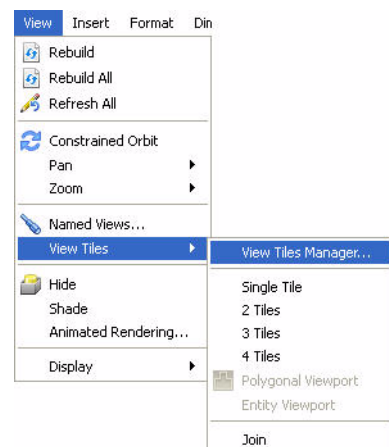

## Graphics Cursor / Crosshairs

Outside the graphics area, the cursor assumes the typical Windows pointing shape. Within the graphics area, the mouse cursor appears as  crosshairs during an active command.

The crosshairs act as the pointer in this application. The crosshairs indicate the pointer position in the graphics area. As with the coordinate symbol, the pointer symbol also changes when the drawing view changes from a default plan view (viewed from above) to an isometric view.

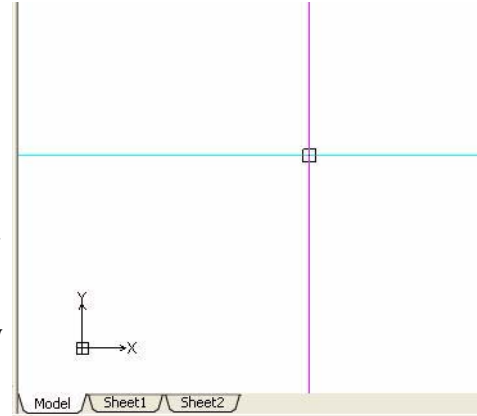

## Cartesian Coordinate System / Origin

A coordinate system determines each Point of a drawing surface or entity unambiguously. DraftSight uses the Cartesian coordinate system consisting of three coordinate axes. Axes are arranged orthogonally, crossing at the origin. All axes use the same measurements.

All drawings are based on a Cartesian coordinate system in which perpendicular axes are used: the X, Y axes. The intersection of the two coordinate axes forms a Point call the origin.

All axes originate at the origin of the coordinate system. The X axis and Y axis define a horizontal plane and is located in the lower left corner of the graphics area.

The Coordinate symbol is a visual reference to the drawing. This symbol indicates the position of the axes of the coordinate system and provides orientation of the alignment of the coordinate system. The directions of the arrows displayed on the axes identify the positive side of the coordinates.

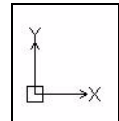
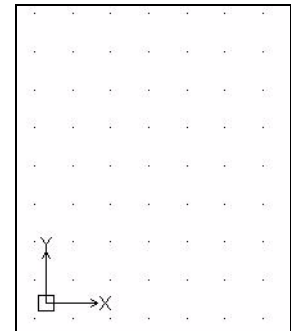

## Coordinate System

The Coordinate System (CCS) icon is known as the coordinate symbol. By default, the CCS symbol and origin is displayed in the graphics area. To control the display of the coordinate system icon click **View, Display, CCS Icon** from the Main Menu or type **csicon** at the Command prompt in the command window.

: **csicon** ↵

Specify option»

- **All:** By default, the CSicon command affects only the current view. The **All** option applies changes to the coordinate system icon in all views. You can choose from **No origin**, **Off**, **On** or **Origin**.
- **No origin:** Displays the coordinate system icon at the lower left corner independent from the origin of the current coordinate system.
- **Off:** Hides the Coordinate system icon.

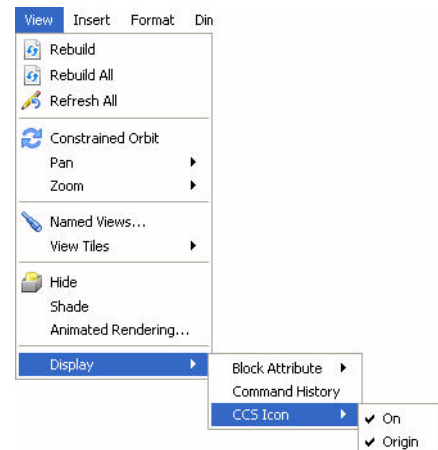

- **On:** Displays the Coordinate system icon.
- **Origin:** Displays the coordinate system icon at the origin (0,0) of the current coordinate system. If the origin is outside of the display, the icon is positioned in the lower left corner.

### Model Tab and Sheet Tab

By default, the desktop contains three tabs on the bottom left labeled:

- Model
- Sheet1
- Sheet2

Select the desired page by clicking the appropriate tab, which displays your drawing either as a model or as a layout sheet in your drawing.

You change the drawing environment between the Model Tab (for drawing entities) and Sheet Tabs (for layouts for printing/plotting).

Create your design in the Model (Model tab), and then create layouts to print/plot your drawing on a Sheet (Sheet tab).

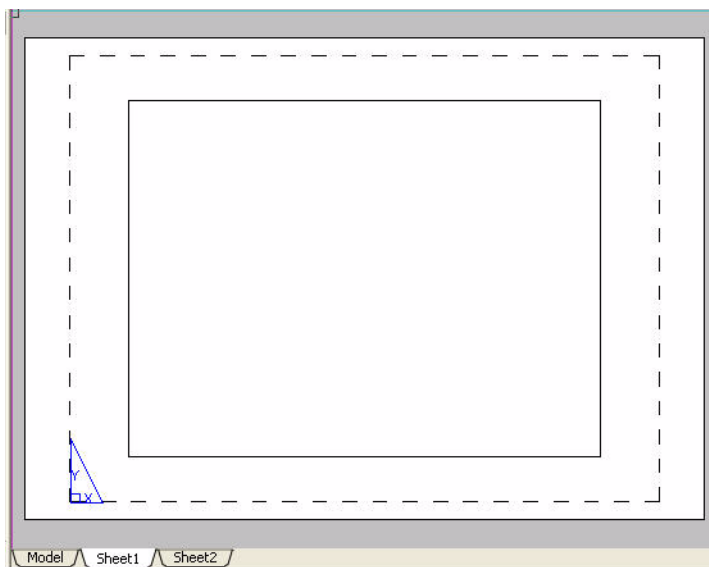

#### NOTE:

Work with multiple Sheets (layouts) using the **Sheet** command to perform additional options.

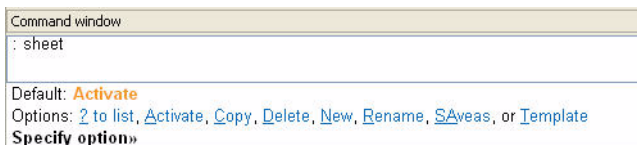

## Command Window

The command window provides the ability to enter commands and communicate between you and the drawing.

The command window is located at the bottom section of the screen and provides status information and prompts you for the next step.

Press <F2> to display the command history in a separate window. When the command window dialog box is displayed, you can scroll through the command history. Press <F2> again to close the command window dialog box.

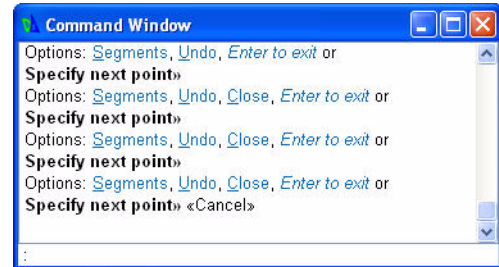

You can move the floating command window anywhere on the screen and resize its width and height by dragging a side, bottom, or corner of the window.

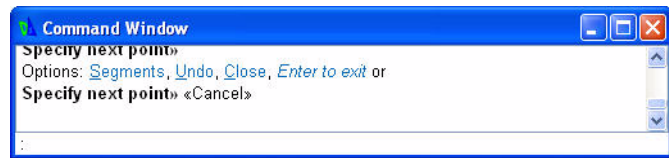

You must press the **Enter** key (↵) after typing a command or entering a command option. The command window continues to inform you of the type of responses(s) that you must enter, until the command is either completed or terminated.

Each command (**Line**, **Circle**, etc.) has its own series of prompts. The prompts in the Command prompt area that appear when a particular command is used in one situation may differ from the prompts or sequence or prompts when invoked in another situation.

There are three way to terminate a command:

- Complete the command and return to the : prompt.
- Press the **Esc** key to terminate the command.
- Enter another command from one of the menus or toolbars, which automatically cancels any command in progress.

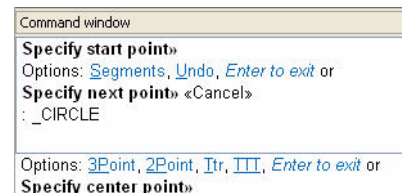
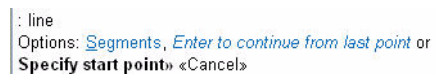
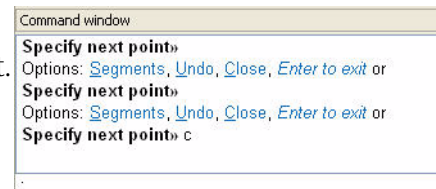

## Status Bar

The Status bar is located beneath the command window and is divided into three sections: Tool tip display, Drafting tools, and Current coordinate display.



- **Tool tip display.** The left hand side of the status bar displays tool tips. If you move the cursor over toolbar icons, a brief description of the corresponding command or function displays in the tool tips area. Descriptions of commands selected from any of the pull-down menu items also display in this area.
- **Drafting tools.** Drafting tools make it possible to create and modify entities more easily and accurately. Each of these drafting tools can be toggled On when needed and toggled Off when not. When used appropriately, these commands provide the power, speed, and accuracy associated with 2D CAD drafting. The following drafting tools are available:
  - Snap** (Snap Grid)
  - Grid** (Grid Display)
  - Ortho** (Orthogonal Drawing Mode)
  - Polar** (Polar Guides)
  - ESnap** (EntitySnap)
  - ETrack** (Entity Tracking Guides)
- **Current coordinate display.** The information field at the right of the buttons shows the X, Y, and Z coordinates of the crosshair (cursor) position.

## Snap (Snap Grid)

The **Snap** command provides an invisible grid in the graphics area. With Snap on, the cursor can only select Points at designated (X, Y) coordinates.

Use the **Snap** command to determine the distance between snap Points.

Snap spacing may or may not be equal to the Grid spacing.

You can also use an Isometric style of snap. Use isometric snap to create 2D isometric drawings representing 3D entities.

## Grid (Grid Display)

The **Grid** command is used to display a visible pattern of dots. With **Grid** on, a latticed-point grid is displayed in the graphics area to help visualize distances, angles, and entity relationships.

The grid is a drawing tool and is not part of the drawing. It will not be printed or plotted. The Grid spacing may or may not be equal to the Snap spacing.

## Ortho (Orthogonal Drawing Mode)

The **Ortho** command limits the cursor movement so that it moves parallel to the axes of the current coordinate system. With **Ortho** on, you can only enter Points located parallel to these axes. The **Ortho** command makes it easier to draw and place parallel or colinear Lines on entities.



### Polar (Polar Guides)

The **Polar** command draws at exact angles at fixed intervals, starting from 3 o'clock (or East), and at additional angle increments. With **Polar** on, the angular direction and the distance from the last Point selected will be tracked and displayed according to the settings.

### ESnap (EntitySnap)

The **ESnap** command provides the ability to detect and snap to geometrically significant Points on drawing entities, for example; end points, intersections, and center Points. Snapping to a significant Point provides an exact position for drawing and editing commands.

The **ESnap** command opens the Pointer Control settings of the Drafting Options dialog box so that you can set EntitySnap.

### ETrack (Entity Tracking Guides)

The **ETrack** command helps you draw entities at specific angles or in specific relationships to other entities. With **ETrack** on, temporary alignment guides help you create entities at precise positions and angles. **ETrack** works with **ESnap** and polar angle settings. You must set an EntitySnap before you can track from an ETrack Point.

#### NOTE:

While **Grid**, **Snap**, **Ortho**, **Polar** and **ESnap** commands do not create entities, They make it possible to create them more easily and accurately.

### Palettes

Palettes are non-fixed areas on the left or right side of the graphics area which provides the ability to display or manage drawing entities. The available Palettes are:

- **Properties Palette:** Allows you to view and change properties of entities in a drawing. The palette displays the entity's properties including the coordinates and data that define its geometry. If more than one entity is selected, the palette displays only those properties common to all entities in the selection, such as **Layer**, **LineColor**, **LineScale**, **LineWeight** and **Hyperlink**. If the common properties are not identical in all of the selected entities, the corresponding drop-down list or edit field of the palette displays <<Varies>>.
- **References Palette:** Lets you control and manage Referenced drawings or image files. When you open a drawing that contains Referenced drawings, they are displayed in their current state. When multiple people work on a project over a network, it might be necessary to update the external references. The program reloads the specified drawings in their most recent saved states.

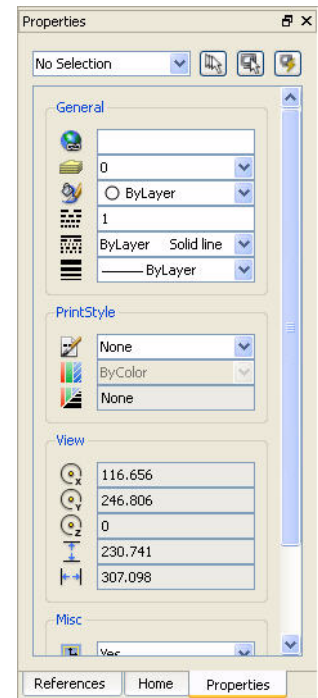

- **Home Palette:** Contains centralized links to online and web resources, design elements, and the latest in CAD news. The two default sections are: Community and Latest News.

**NOTE:**











You can display or hide the Tool Palettes at any time to increase your graphics area. Tool Palettes can also be resized or minimized.

## Zoom Commands



The **Zoom** command is like a zoom lens on a camera. You can increase or decrease the viewing area, although the actual size of the entities remains constant.

As you increase the visible size of entities, you view a smaller area of the drawing in greater detail as though you were closer. DraftSight provides you with numerous view options on the Zoom toolbar and the View drop-down menu. The available default tools on the Zoom toolbar are:

-  **Zoom Center:** Allows you to specify a center Point for the new view and magnification value or height.
-  **Zoom Dynamic:** Allows you to zoom in and out of the drawing window at real-time.
-  **Zoom Previous:** Allows you to undo the last zoom operation. You can restore up to ten previous displays.
-  **Zoom Window:** Allows you to show a selected part of a drawing in the largest possible scale.
-  **Zoom Selected:** Calculates the boundary of the area that contains the specified entities and zooms in or out so the entities are visible on the screen.
-  **Zoom Factor:** Allows you to zoom the display by a scale factor. This is helpful when working with sheets or when plotting or printing the drawing.
-  **Zoom In:** When you zoom in, the view of the drawing enlarges.
-  **Zoom Out:** When you zoom out, the view of the drawing reduces.
-  **Zoom Bounds:** Displays the entire drawing even if only a portion of the drawing has entities. Zoom Bounds zooms to the bounds of the drawing if no entities extend beyond these bounds. If entities extend beyond the defined bounds, they are included in the calculation of the boundaries in which to zoom.
-  **Zoom Fit:** Displays the drawing with all its elements as large as possible. Unlike Zoom Bounds, Zoom Fit ignores drawing bounds. Zoom Fit includes entities on Layers that are turned off but does not include those on frozen Layers.

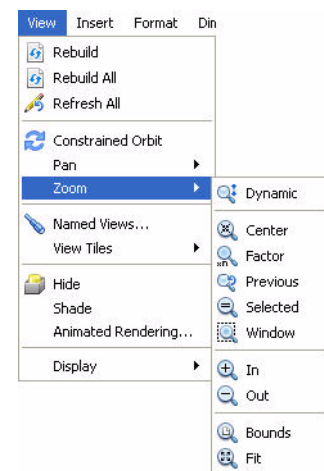



















## Draw Toolbar



The default Draw toolbar contains all commands that relate to drawing 2D geometrical entities. You can use these drawing tools to create new entities such as Lines, Arcs and Circles.

The available default tools on the Draw toolbar are:













-  **Line:** Creates straight Line segments.
-  **Infinite Line:** Creates a set of one or more Lines that extend infinitely in both directions from an origin. Use InfiniteLines to create frameworks or grids for use in drawing construction.
-  **Polygon:** Creates an equilateral closed PolyLine. A polygon is a closed linear PolyLine segment consisting of between 3 and 1024 equal length sides.
-  **Rectangle:** Creates a rectangular PolyLine segment. Draw rectangles with any size or orientation in the plane with square, filleted, or chamfered corners.
-  **PolyLine:** Creates PolyLines. A PolyLine consists of connected Lines or connected arc segments. You can create PolyLines with segments of different widths and fill settings. The default segment type for a PolyLine is a linear segment.
-  **Arc:** Creates an arc segment. Construct arcs of any length or radius. All Arcs are drawn from a start Point in the positive horizontal direction.
-  **Circle:** Creates a Circle segment. The default method for drawing a Circle is to specify a center point and a radius.
-  **Ellipse:** Creates an Ellipse segment. An Ellipse has a center like a Circle, but has a longer radius along its major axis and a shorter radius along its minor axis.
-  **Ellipse Arc:** Creates an Ellipse Arc segment. An Ellipse has a center like a Circle, but has a longer radius along its major axis and a shorter radius along its minor axis.
-  **Point:** Creates a Point, usually used as reference in drawings. A Point is a reference to an pattern holding the x and y coordinates of the Point.
-  **Spline:** Creates quadratic or cubic Spline curve. A Spline is a smooth curve that is fit to a set of Points. You can create a non-uniform rational B-Spline or (Nurbs) curve for any number of fit Points. You can also fit the Spline to the specified Points to within a specified tolerance value.
-  **Hatch/Fill:** Fills a specified boundary with a pattern. Hatch patterns can greatly increase the clarity and legibility of a drawing. You can fill enclosed areas or selected entities in drawings with different types of hatch patterns or a solid hatch fill.
-  **Make Block:** Defines a Block from selected entities. A Block is a collection of entities bound together as a single entity.
-  **Region:** Converts an entity enclosing an area into a Region. Transforms an entity that forms a closed shape into a Region. You can use the command to combine all entities of any closed loop - such as closed PolyLines (including polygons and donuts), Circles, Ellipses, and closed Splines - into one entity.
-  **Note:** Creates paragraph text entities that have the same text formatting applied to each line of text in the paragraph.
-  **SimpleNote:** Displays text on screen as it is entered. Create Text lines of any position, orientation, justification, height and TextStyle.







## Modify Toolbar



Use the Modify toolbar to modify the entities in your drawing.

The available default tools on the Modify toolbar are:

-  **Delete:** Removes entities from the drawing.
-  **Copy:** Duplicates drawing entities by selecting drawing entities and placing a copy of them at a specified position. The duplicated entities are exact copies of the selected entities including all entity properties such as Layer, LineStyle, LineColor, and LineWeight, as well as the outline of the entities. Based on one selection set, you can create multiple copies.
-  **Mirror:** Copies selected entities onto the opposite side of a specified mirror line. To define the mirror axis, specify two Points.
-  **Move:** Repositions drawing entities within the coordinate system without changing their orientation or size.
-  **Offset:** Creates parallel shapes of Lines, PolyLines, Circles, Arcs, Ellipses, Elliptical Arcs, Splines, rays, and InfiniteLines. A copy of a selected entity is placed at a specified distance from the original entity. The original entity stays in position.
-  **Pattern:** Creates multiple copies of selected entities in a rectangular matrix or a polar, circular pattern. The created entities inherit all properties of the original entities such as Layer, LineStyle, LineColor, and LineWeights.
-  **Rotate:** Rotates entities through an angle, about a base point. The base point is the Point about which rotation occurs, typically a corner or a center of an entity. If the base point is the corner of a selected entity, the entity rotates on that corner. If the base point is the center of a selected entity, the entity stays in the same relative position, but spins about the base point.
-  **Scale:** Enlarges or reduces entities while keeping proportions the same.
-  **Stretch:** Changes the position of an entities nodes, while retaining their relation to other nodes in the entity. Stretching enlarges or reduces entities in only one direction, unlike scaling. Use stretching also to move single entities inside of a contour.
-  **Chamfer:** Allows you to connect two Lines with a beveled corner. The selected entities do not have to intersect, and they can overlap. If the entities overlap, they will be trimmed to create the beveled corner.
-  **Fillet:** Allows you to create rounded corners by replacing parts of two Lines with an arc. The filleted entities do not have to intersect, and they can overlap. If the entities overlap, they are trimmed to create the rounded corner and the Lines to be filleted are connected to the fillet arc.
-  **Split at Point:** Breaks an entity at a specific Point.
-  **Split:** Erases a part of an entity between two Points you select. Use Split as a construction tool or to create a gap between two parts of an entity to place text or a symbol. Use the command with Lines, Circles, Arcs, polyl ines, Ellipses, Splines, InfiniteLines and Rays, but not with Rich Lines.









-  **Weld:** Merges two entities into a single entity. You can merge Lines, open PolyLines, Arcs, Elliptical Arcs or open Splines. You can also transform Arcs to Circles and Elliptical Arcs to Ellipses.
-  **Extend:** Allows you to edit entities that have common boundary edges. Extend expands parts of entities to the intended boundary edge, letting you close polygons precisely or extend entities to the proper boundary edge. As a drawing entity expands, they do not change direction. A Line remains a Line, and an Arc remains an Arc.
-  **Trim:** Cuts drawing entities precisely at the edges defined by one or more entities. Use Lines, InfiniteLines, rays, PolyLines, Circles, Arcs, or Ellipses as cutting edges to trim the selected entity. Blocks and text cannot be trimmed or used as cutting edges. On sheets, viewtiles can be cutting edges.
-  **Edit Hatch:** Modifies hatch patterns, solid color fills or gradient color fills. You can then add additional entities to the set of entities to be hatched or filled.
-  **Display Order:** Changes the drawing and printing order of any entity in the drawing database. You can move entities to the 'front' or 'back' of the sort order. You can also order entities relative to other entities, that is, above or below a selected entity.
-  **Edit PolyLine:** Edits PolyLines or PolyLine vertices by opening a closed PolyLine or closing an open PolyLine. Joining a PolyLine with other drawing entities such as Lines, Arcs or PolyLines. You can also change the width of the whole PolyLine and also edit the vertices of individual PolyLine segments.
-  **Explode:** Breaks a complex entity into its component entities. You can explode Blocks and other complex entities like PolyLines, Hatches and Dimensions.









## EntitySnap Toolbar



EntitySnap tools are available on the EntitySnap toolbar. They allow for precise drawing within DraftSight. For example, a rectangle can be drawn from the exact endpoint of an existing Line by simply selecting the **Snap to Endpoint** tool, or you can draw a Line from the center point of a Circle using the **Snap to Center** tool.

The available default tools on the EntitySnap toolbar are:

-  **Snap From:** Locates a Point offset from a reference Point within a command.
-  **Interference Point:** Creates a temporary Point used by Esnap.
-  **Snap to Visual Intersection:** Snaps to the apparent intersection of two entities.
-  **Snap to Intersection:** Snaps to the intersection of two entities.
-  **Snap to Endpoint:** Snaps to the closest end point of an entity.
-  **Snap to Extension:** Snaps to the phantom extension of an Arc or Line.
-  **Snap to Midpoint:** Snaps to the mid point of an entity.
-  **Snap to Center:** Snaps to the center of an Arc, Circle, Ellipse or Elliptical Arc.
-  **Snap to Quardant:** Snaps to a quadrant point of an Arc, Circle, Ellipse or Elliptical Arc.



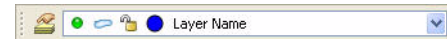

-  **Snap to Tangent:** Snaps to the tangent of an Arc, Circle, Ellipse, Elliptical Arc or Spline.
-  **Snap to Insert:** Snaps to the insertion point of entities such as Text, Blocks or Attributes.
-  **Snap to Node:** Snaps to a Point entity
-  **Snap to Parallel:** Snaps parallel to a specified Line.
-  **Snap to Perpendicular:** Snaps to a Point perpendicular to an entity.
-  **Snap to Nearest:** Snaps to the nearest Point on an entity.
-  **Snap to None:** Suppresses running EntitySnap for the selection.
-  **ESnap Settings:** Sets running EntitySnap modes.

## Layers Toolbar



Use the Layers toolbar to create new Layers, designate active Layers, and set layer properties.

The available default tools on the Layers toolbar are:







-  **Layers PropertyManager:** Controls Layer and layer properties. The Layer command creates and controls Layer and layer properties.
-  **Show/Hide:** Shows or hides a layer on the drawing. When a layer is shown, it is visible. Hidden Layers are invisible. You cannot select entities on a hidden layer.
-  **Freeze:** Suppresses or un-suppresses a layer on the drawing. When you Freeze a layer, you cannot select or modify entities on the layer. You cannot suppress (Freeze) the active layer.
-  **Lock/Unlock:** Protects or un-protects a selected layer on the drawing. When a layer is protected, you cannot edit the layer. You can only edit unprotected Layers.
-  **LineColor:** Displays the LineColor of the layer assigned layer LineColor.
- **Layer name:** displays the active name layer.







## Layer Tools Toolbar



Use the Layer Tools toolbar to create new Layers, designate active Layer, and set layer properties.

The available default tools on the Layer Tools toolbar are:

-  **Hide Layer:** Entities on hidden Layers are invisible. you cannot select entities on hidden Layers.
-  **Show All Layers:** All Layers in the drawing become visible except those that are suppressed.
-  **Freeze Layer:** When a layer is frozen, it is protected and invisible.
-  **Thaw All Layers:** Thaws all Layers in the drawing, making them visible again.
-  **Lock Layer:** When you lock a layer, you cannot select or modify entities on the layer.
-  **Unlock Layer:** When you unlock a layer, you can edit entities on the layer.
-  **Isolate Layer:** Use the Isolate Layers command to isolate Layers by hiding Layers. You cannot edit entities on these Layers.

-  **Unisolate Layer:** Turns on Layers that were turned off with the last Isolate Layer command.
-  **Activate layer:** You can activate a layer by specifying an entity on that layer.
-  **Entity to Activate Layer:** This will change the Layer of the selected entity to the active layer.
-  **Change Entity's Layer:** This will change the Layer of selected entities to that of a selected entity.
-  **Layer Delete:** Deletes the layer of a selected entity.
-  **Restore Layer's State:** This will undo previous changes made to layer settings.

**NOTE:**

Click **Format, Layer** from the Main Menu to display the Layers Manager dialog box.

Click **Format, Layer Tools** from the Main menu to display the available Layer tools.

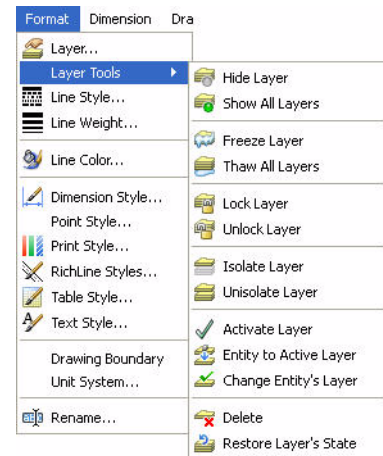

## Properties Toolbar

The Properties toolbar provides the following menu options:

- **LineColor.** You can assign LineColors to drawing entities directly or through Layers. The **LineColor** command lets you determine the color of new entities.
- **LineStyle.** Use the **LineStyle** command to load and set LineStyles. Choose a LineStyle to display on the active segment of the drawing.

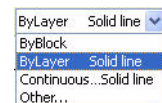
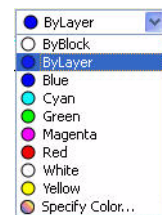
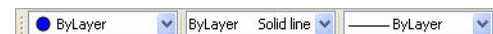

- LineWeight.** Determines that the entity inherits the LineWeight associated with its layer. LineWeight defines how thick or thin an entity appears. The LineWeight of entities does not change when you zoom in or out.

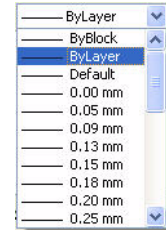

**NOTE:** The default layer is called 0. It is automatically generated by the program when a new drawing is created.

### Mouse Buttons

It is important to understand the basic functions of the mouse buttons. It is recommended that you use a three button mouse with DraftSight.

- Left mouse button:** The left-mouse button is used to select menus and icons, or a graphic entity. A single click is used to select icons, menus and entities.
- Middle mouse button (scroll wheel):** The middle-mouse button is used to zoom in or zoom out in the graphics area. Also, pressing the scroll wheel will allow you to pan the drawing.
- Right mouse button:** The right-mouse button is used to bring up the Context menu in the graphics area or additional available options during the execution of a command.

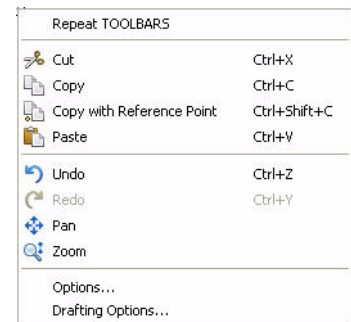

### Cancel or End Command

The **Esc** key is used to cancel the command in the Command prompt. For some commands, the **Esc** key is used to exit the command. If a command is active, you can also right-click in the graphics area and click either **Enter** or **Cancel** from the Context menu.

**Enter:** Confirms default options of the command or ends entity selection.

**Cancel:** Ends a command.

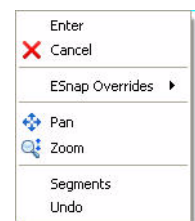
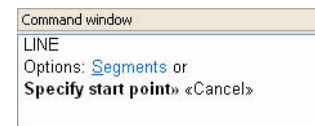



## Help

DraftSight has a comprehensive help function that is designed to assist you. The DraftSight help screen is displayed in its own window with two menu tabs. Click **Help, Help**  from the Main Menu to view the comprehensive DraftSight help screen. You can also activate the help menu by pressing the <F1> key on the keyboard.

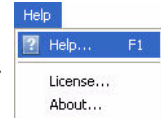

## Manipulating Toolbars

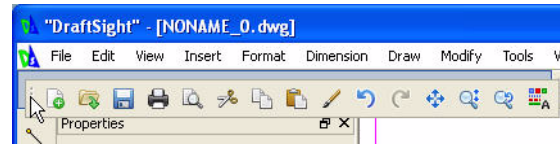

## Move

You can reposition toolbars and set visibility. Each toolbar has a drag handle. Drag and drop toolbars to convenient positions in the application window. You can also dock them below the Main Menu or at the left and right margins of the application desktop.



## Display

Toolbars are available for most DraftSight tools. Named toolbars assist you in performing specific drawing tasks.

Only the most frequently used toolbars are displayed by default.

Right-click the Main Menu or a docked toolbar. Click **Toolbars**. The **Select Toolbars** dialog box is displayed.

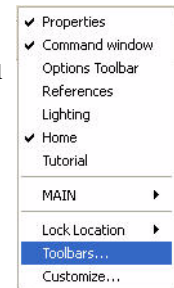

Check or uncheck the desired toolbars to be displayed.

Click the **Customize** button to display the **Customize Commands** dialog box. This box provides the ability to customize a toolbar, or to create your own custom toolbar.

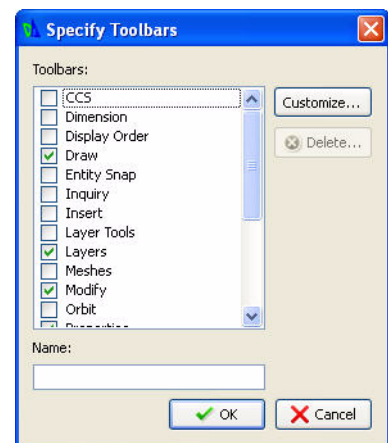





## Lesson 1 QUICK START

When you complete this lesson, you will be able to:

- Create a new drawing
- Set the drawing Unit System and Drawing Boundary
- Set the Snap and Grid
- Utilize the Line, Arc, and Circle Draw tools
- Utilize the Save, Save As, and Open a drawing command
- Apply the Window Select and Cross Selection methods
- Delete a single entity and multiple entities
- Manipulate EGrips in an entity
- Move a single entity and multiple entities
- Understand relative and absolute coordinates
- Use the Command window, Command prompt and Status bar
- Print / Plot a drawing
- Apply the Pan and Zoom commands
- Correct drafting mistakes

## Quick Start

CAD systems in general create designs using basic geometric entities. Many of the constructions used in designs are based on two-dimensional planar geometry. In this section, you will use the **Line**, **Arc**, and **Circle** Draw tools to create geometric entities.

Straight Lines and Circles are used in most technical designs. Triangles and polygons are planar figures bounded by Lines. Splines and Ellipses can be created by connecting arcs with different radii.

## Start a DraftSight Session

### 1 Start a DraftSight Session.

From the Windows Start menu, click **Start, All Programs, Dassault Systemes, DraftSight**.



### TIP:

If you created the DraftSight icon on your desktop, double-click the icon to start the DraftSight session.

## Creating a New Drawing

### 2 Create a New Drawing

Click the **New** icon  on the Standard toolbar. The **Select Template** dialog box is displayed.

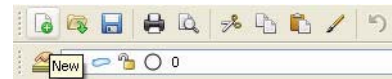

## Drawing Template

Drawing templates act as a basis for your finished work and set up the required drawing environment. Using templates saves time because you can reuse the elements and settings of an already existing drawing.

### 3 Select a Default Drawing Template.

Select **standard.dwt** from the **Specify Template** dialog box.

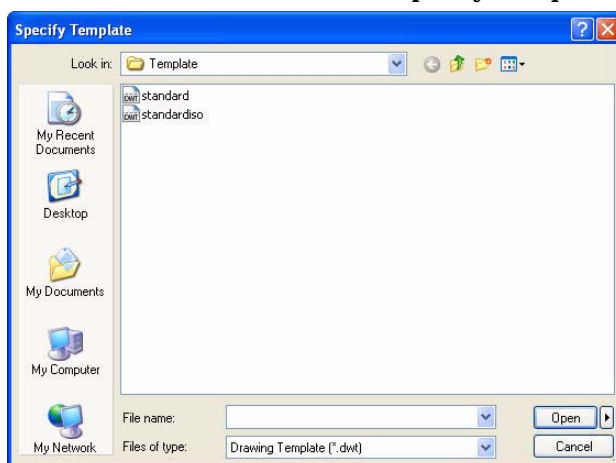

### 4 Click Open.

## Set the Drawing Environment

Set **System Units**, drawing **Boundary**, **Snap** and **Grid**. These settings are stored in your default drawing template.

## Set Drawing Unit System

The **Unit System** section of the **Options - Drafting Settings** dialog box, provides the ability to set: **Base Angle**, **Length Type** and **Precision**, **Angle Type** and **Precision**, as well as **Units scale** for the drawing.

Five different units systems are available:

- Scientific
- Decimal
- Engineering
- Architectural
- Fractional

The default units system is the Decimal system and can be applied to either English (inches) or metric values (millimeters).

### 5 Set Linear Length Precision.

The **Unit System** section of the **Options - Drawing Settings** dialog box allows you to set the linear and angular unit formats.

Click **Format, Unit System...** from the Main Menu. The **Unit System** portion of the **Options - Drawing Settings** dialog box is displayed.

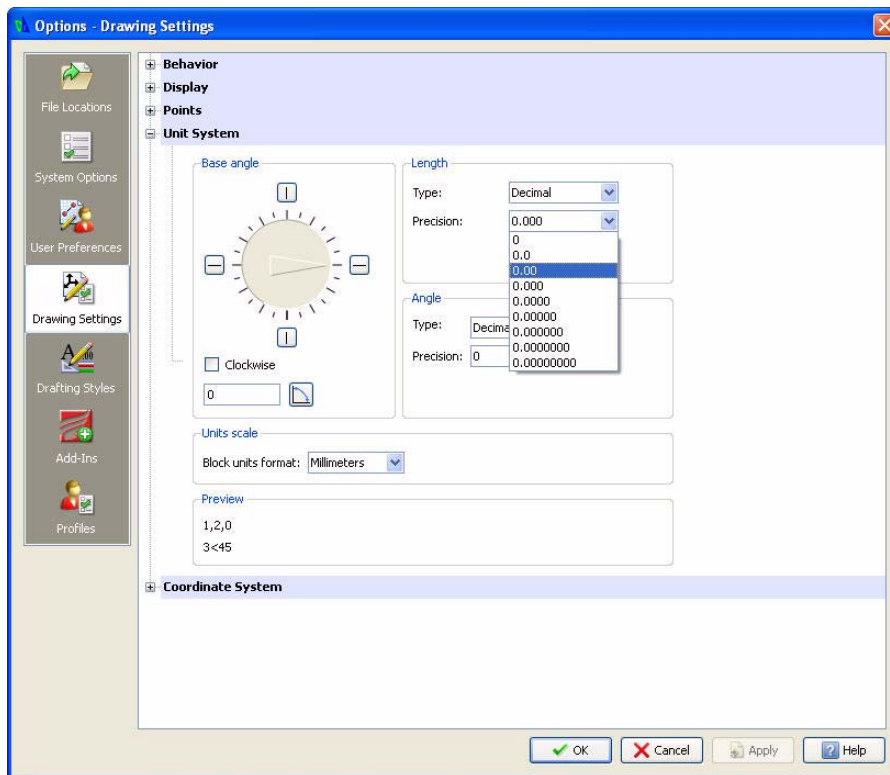

Click **0.00** for **Precision** in the **Length** section of the dialog box.

**6 Set Linear Units Scale.**

The **Units scale** section of the **Unit System** dialog box allows you to set the linear and angular unit formats.

Click **Millimeters** for **Block units format** in the **Units scale** section of the dialog box.

Click **OK**.

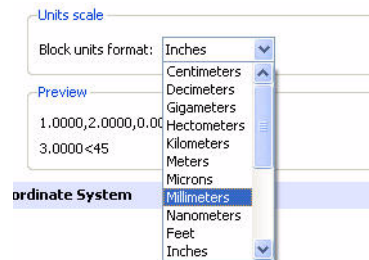

**Set Drawing Boundary**

The Drawing Boundary defines the extent of the grid display and restricts the graphics area. The Drawing Boundary can be helpful for printing/plotting; if you set your graphics area so that it scales directly to the default drawing sheet.

Drawing Boundary does not affect the display on the screen. Boundaries are expressed as a pair of Points in the World Coordinate System (WCS), a lower left and an upper right limit.

For example, to set limits for an A4 (metric) vertical sheet size, set the lower left as 0,0 and upper right as 210,297.

Usually drawing boundaries are relative to the paper size to be used when printing/plotting a drawing.

Default drawing sheet sizes - Millimeters are:

- A4 - 210 x 297
- A3 - 297 x 420
- A2 - 420 x 594
- A1 - 594 x 841
- A0 - 841 x 1189

Default drawing sheet sizes - Inches are:

- A - 8.5 x 11.0
- B - 11.0 x 17.0
- C - 17.0 x 22.0
- D - 22.0 x 34.0
- E - 34.0 x 44.0

In the next section, set the drawing boundary to use a horizontal A4 default drawing sheet.

**7 Set Drawing Boundary.**

Click **Format, Drawing Boundary** from the Main Menu.

Default: (0.00, 0.00)

Options: OFF, ON or

Specify lower left corner» ↵

Default: (12.00, 9.00)

Specify upper right corner» **297,210**↵

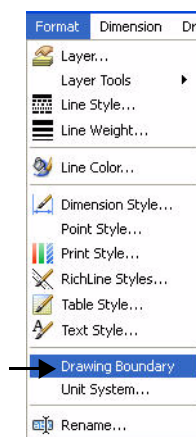

**NOTE:**

Press the **Enter** key to accept the default command, complete the command or continue to the next step. Press the **Enter** key again to repeat the command

**TIP:**

Use the command window to view the transcript of the commands entered, so you can read or reconstruct your working steps, including keyboard inputs.

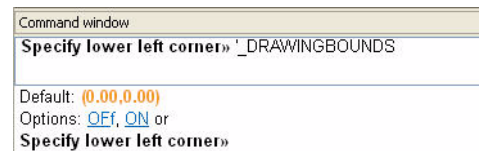

## Set Snap and Grid

The Snap is an invisible grid in the graphics area. With Snap activated, the cursor can only select Points positioned directly on the snap grid. When you Point to the drawing, startpoints, endpoints, center points, and other specific Points are exactly on a Point of the snap grid.

The Grid is a pattern of evenly spaced dots that serve as a visual distance reference. The Grid is not part of the drawing file and does not appear in the printed output.

You can set the Grid to span the graphics area or limit it to the extents of the drawing

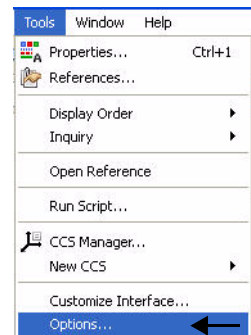
**NOTE:**

The Snap and Grid follow the axis of the coordinate system.

**8 Set Snap and Grid.**

Click **Tools, Options** from the Main Menu.

The **Options** dialog box is displayed.

Click the **User Preferences** tab. Expand **Drafting Options, Pointer Control** and **Snap Settings**.

Click the **Enable Snap <F9>** box.  
 Enter the value of **10** in the **Horizontal Snap spacing** box. Press the **Tab** key The **Vertical Snap spacing** box is updated.

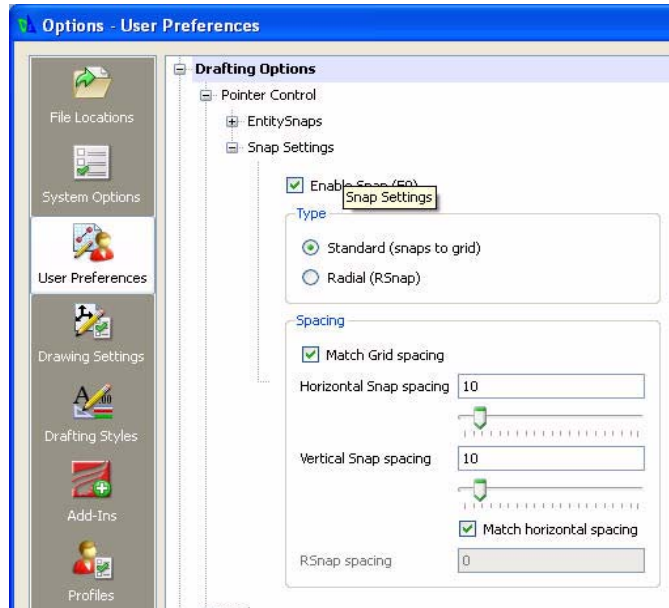

Expand **Display** and **Grid Settings**

Click the **Enable Grid <F7>** box and the **Match Snap Spacing** box. The **Horizontal display spacing** value and the **Vertical display spacing** value will be set to **10.00**.

Click **OK**.

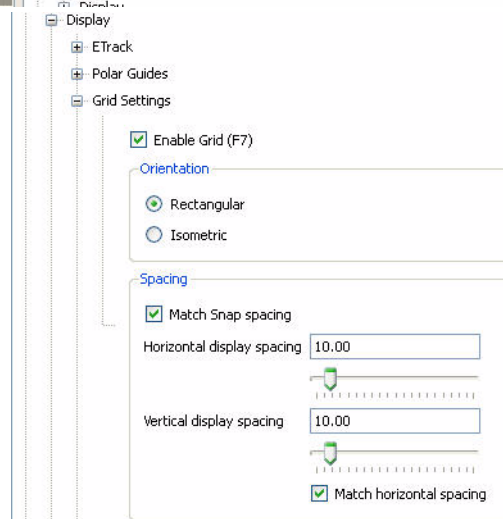

### Zoom Bounds

The **Zoom Bounds**  tool provides the ability to adjust the display so that all entities in the drawing are displayed to be as large as possible.

- Display the Drawing with the New Boundary.**  
 Drawing boundaries need to be used to adjusted to the view.

Select **View, Zoom, Bounds**  from the Main Menu.

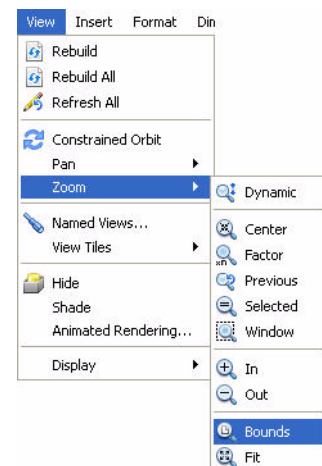

**NOTE:**

You can also select the **Zoom Bounds** icon on the Zoom toolbar if it is active, or type the following at the command prompt:

: **Zoom** ↵

Default: Dynamic

Options: **B**ounds, **C**enter, **D**ynamic, **E**it, **P**revious, **S**Elected, *specify a scale factor (nX or nXP)* or

Specify first corner >> **B** ↵

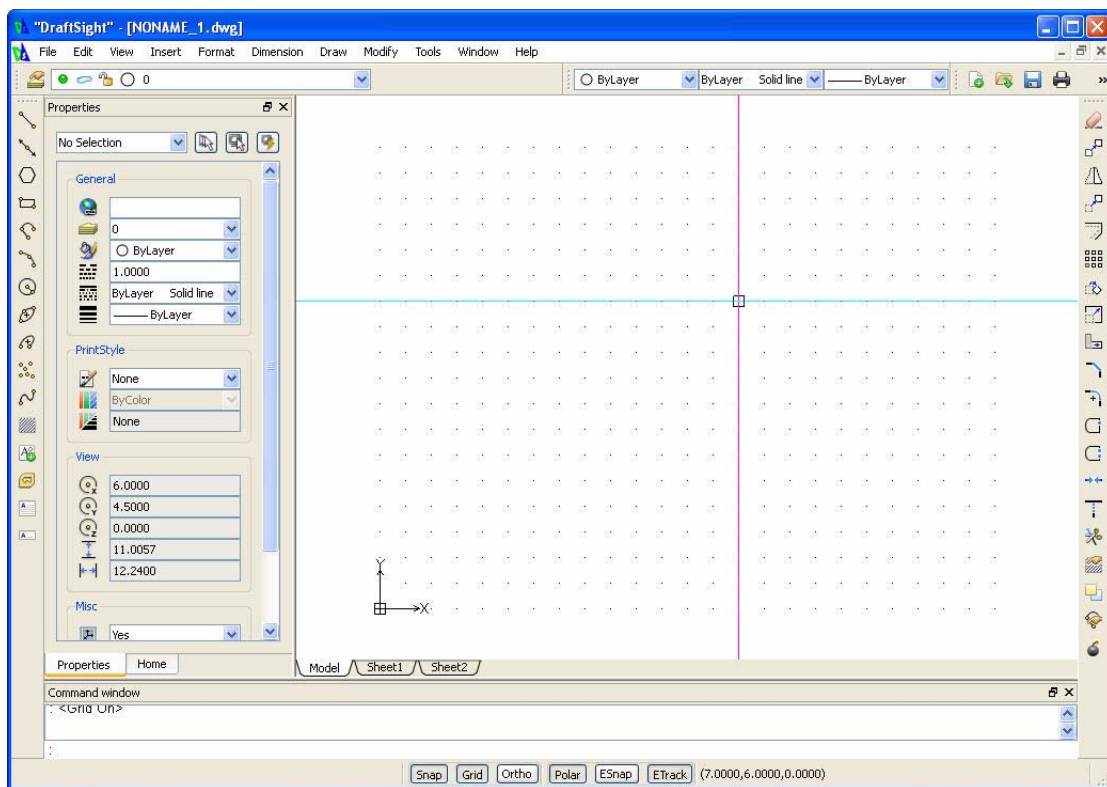

## Line Command

The **Line**  command provides the ability to draw a straight Line segment between two defined Points. Each segment in a series of connected Lines is a separate entity.

This book only focuses on the 2D drawing abilities of DraftSight.

There are four ways to define the length and position of a Line:

1. Randomly select Points.
2. Set a specific value for the Snap function and select Points using the Snap spacing values.
3. Enter the absolute coordinate values for the start and endpoints.
4. Enter the relative coordinate values and specify the starting Point and the length and direction of the Line.

In the next section, use two dimensional (X,Y) coordinates, and apply the **Line - Snap Point** method.

### 10 Apply the Line Command.

Click the **Line** icon  on the Draw toolbar.

Options: Segments or  
Speci fy start poi nt>>

Click a **grid point** six grid spaces up and six grid spaces to the right of the origin.

Options: Segments, Undo, *Enter to exit* or  
Speci fy next poi nt>>

Click a **grid point** horizontally to the right six grid spaces.

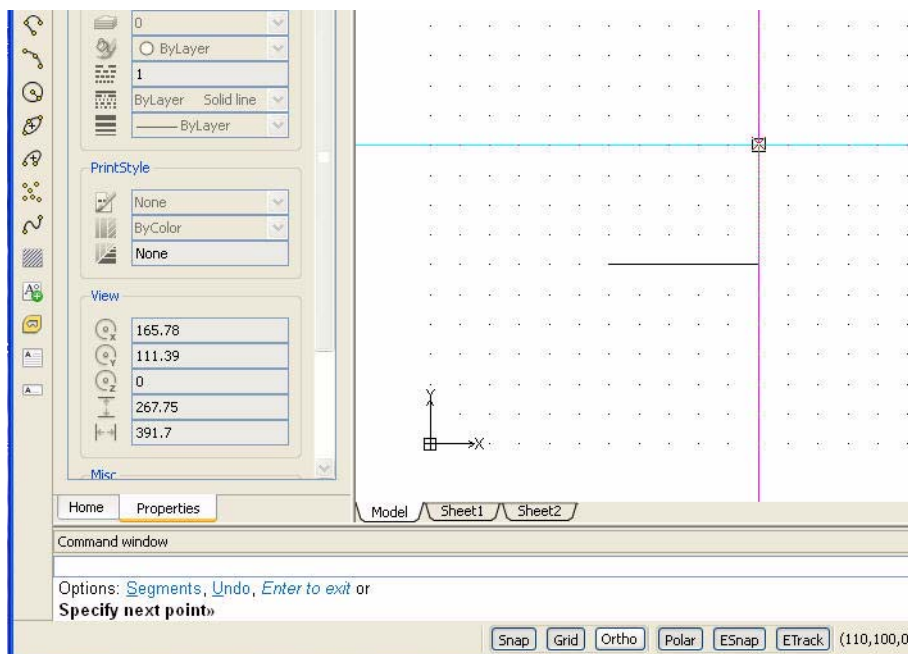

Options: Segments, Undo, Close, *Enter to exit* or  
Speci fy next poi nt>>

Click a **grid point** vertically upward one grid space.

Options: Segments, Undo, Close, *Enter to exit* or  
Speci fy next poi nt>>



Click a **grid point** horizontally to the right two grid spaces.

Options: Segments, Undo, Close, *Enter to exit* or  
Specify next point>>

Click a **grid point** vertically upward four grid spaces.

Options: Segments, Undo, Close, *Enter to exit* or  
Specify next point>>

Click a **grid point** horizontally to the left two grid spaces.

Options: Segments, Undo, Close, *Enter to exit* or  
Specify next point>>

Click a **grid point** vertically upward one grid space.

Options: Segments, Undo, Close, *Enter to exit* or  
Specify next point>>

Click a **grid point** horizontally to the left six grid spaces.

Options: Segments, Undo, Close, *Enter to exit* or  
Specify next point>>

Click the start **grid point**.

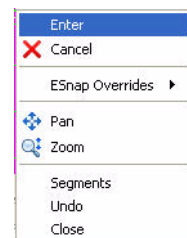

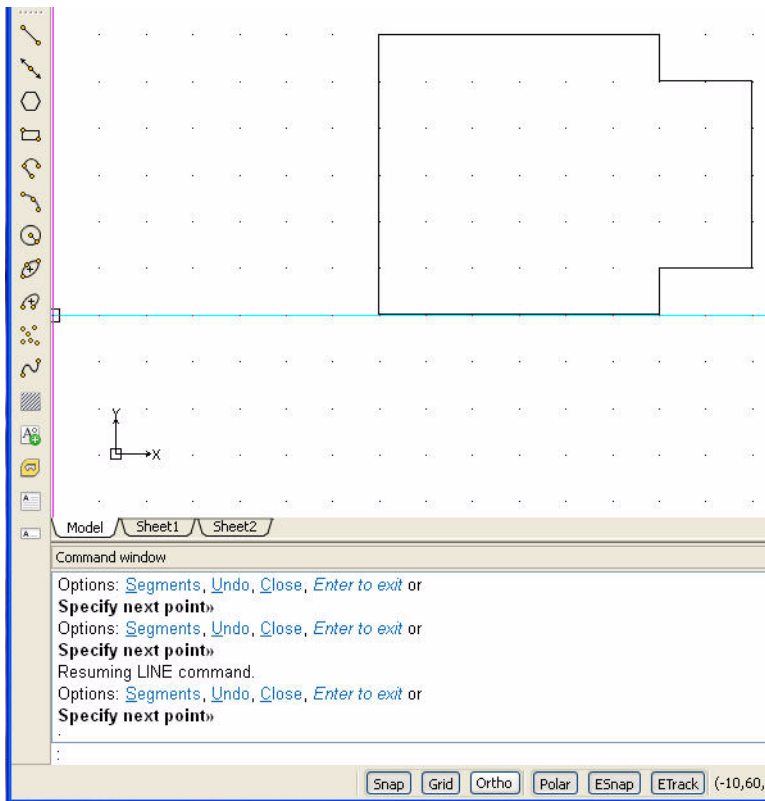

Options: Segments, Undo, Close, *Enter to exit* or  
 Specifi y next poi nt>>↵

**NOTE:** The ↵ symbol means press the **Enter** key.

To close the Line you can also right-click and select **Enter**.

**NOTE:** To undo a Line segment, press **Ctrl + Z** or type **Undo** at the Command Prompt.

**11 Save the Drawing.**

Click the **Save** icon  on the Standard toolbar.

Enter file name: Lesson 1-1.

Click **Save**.

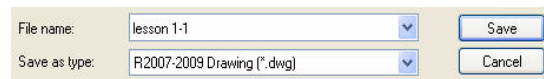

**12 Hide the Grid.**

You can hide or show the grid.



Click the **Grid** button on the Status bar.  
 <Grid off> appears in the command window.

### 13 Show the Grid.

Click the **Grid** button from the Status bar.  
 <Grid on> appears in the command window.

### Note: Snap

Also you can choose to use the function keys.  
 Use <F7> for the Grid toggle and <F9> for the Snap toggle.

### 14 Close the Active Drawing.

Click **File, Close** from the Main Menu.

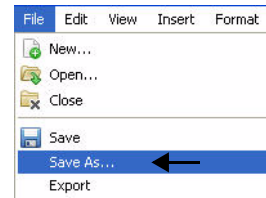

## Open an Existing Drawing

### 1 Open a Drawing.

Click the **Open** icon  on the Standard toolbar.

Select Lesson 1-1 from the list.

Click **Open**.

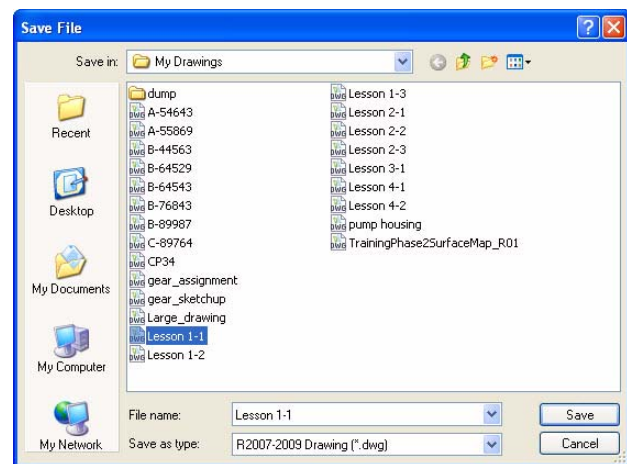

## Delete Command

### Single Entity

The **Delete**  command, located on the Modify toolbar, removes a selected entity while creating, editing, or detailing your drawing.

### 2 Delete an Entity.

Click the **Delete** icon  on the Modify toolbar.

Specify entities>>

Click the right Vertical Line in the drawing.  
 The selected Line is highlighted by turning dotted.

1 found, 1 total

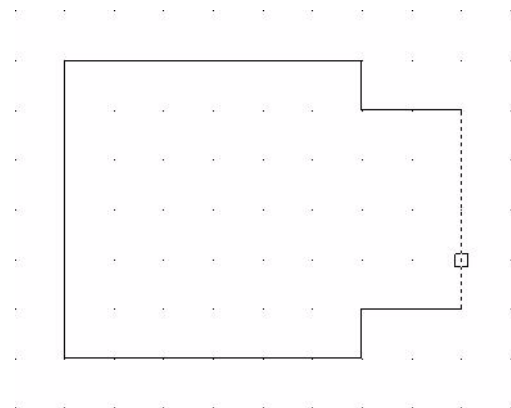

Specify entities>>↵

The linear segment is removed.

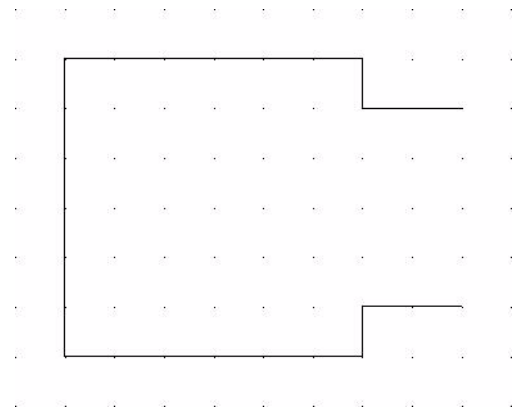

**NOTE:** You can also reverse the order of operation by clicking the Line first and displaying the EGrips, then choosing the Delete icon.

### Arc Command

The **Arc**  command provides the ability to construct arcs of any length or radius. You can also append Arcs to other Line, PolyLine, or Arc entities. All Arcs are drawn from the start Point in the positive horizontal direction.

The available Arc commands are provided later in this section.

#### 3 Draw a Center Point Arc.

Click the **Arc** icon  on the Draw toolbar.

Options: Center or

Specify start point>> **c** ↵

Specify center point>>

Click a grid point centered between the two Horizontal Lines.

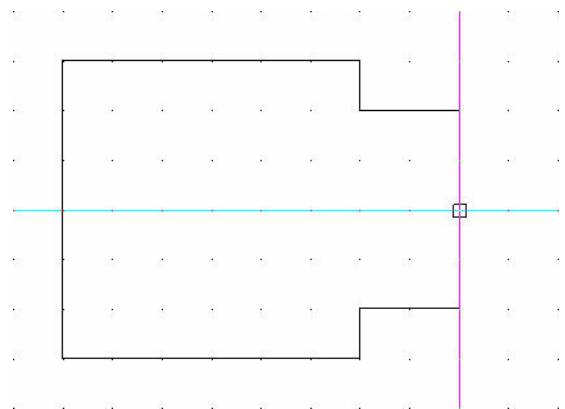

Specify start point>>

Click the endpoint of the bottom right end of the short Horizontal Line. This is your Arc start Point.

Options: Angle, chord Length or

Specify end point>>

Click the endpoint of the top right end of the short Horizontal Line. This is your endpoint.

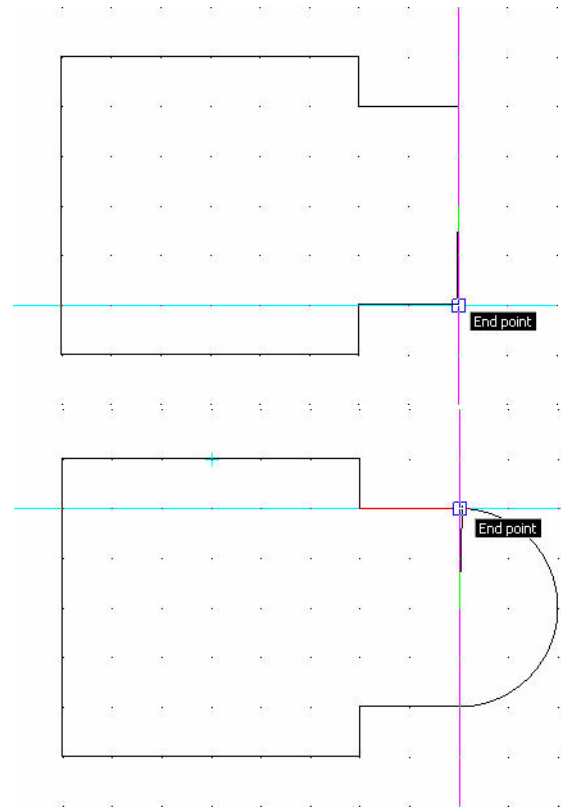

### NOTE:

If **Auto-Save** is on, DraftSight will save a back-up file of your drawing.

## Circle Command

The **Circle**  command provides the ability to use several methods to create Circles of any size. The available Circle commands are provided below.

Circles may be defined by:

- A center point and either a radius or diameter.
- Two or three Points.
- Defining the tangents to two existing Lines or Arcs and then defining a radius value.
- Defining three tangent entities.

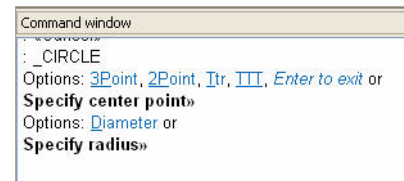

**4 Draw a Circle.**

Click the **Circle** icon  on the Draw toolbar.

Options: 3Point, 2Point, Itr, ITT,  
*Enter to exit* or

Specify center point>>

Click the **center point** of the Arc.

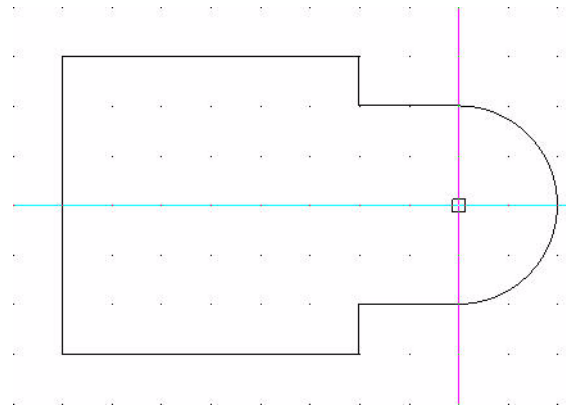

Options: Diameter or

Specify radius>>

Click one **grid point** horizontally to the right.

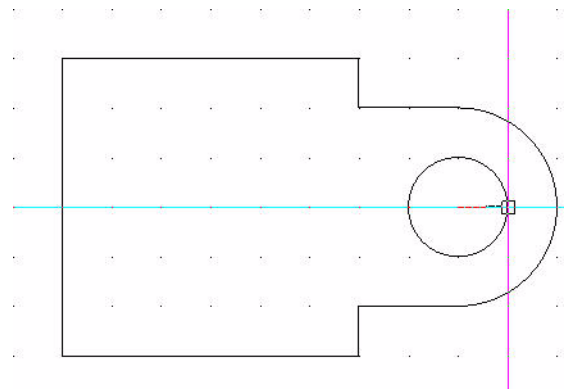

**5 Save the Drawing.**

Click **File, Save As...** from the Main Menu.

Enter File name: Lesson 1-2.

Click **Save**.

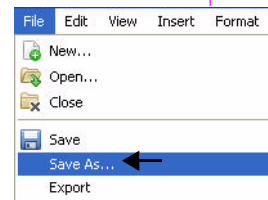

**NOTE:** Use the **Save As...** command to save the drawing under a different name or in a different location

Besides using the Draw toolbar to create an Arc or Circle, you can also select various Draw commands from the drop-down menu in the Main Menu. The available **Circle** commands are:

- **Center, Radius:** click the graphics area to define the center point of the Circle. Click the graphics area to define the Circle radius, or enter the radius in the command window.
- **Center, Diameter:** click the graphics area to define the center point of the Circle. Click the graphics area to define the Circle diameter, or enter the diameter in the command window.
- **2 Points:** click two Points in the graphics area that define the Circle diameter.
- **3 Points:** click three Points in the graphics area that define Points on the Circle.
- **Tangent, Tangent, Radius:** click a Point on each of two entities that are tangent to the Circle to be created in the graphics area. Click a Point in the graphics area to define the radius or enter the radius at the command window.
- **Tangent, Tangent, Tangent:** click a Point in the graphics area on each of three entities that are tangent to the Circle to be created in the graphics area. This option is useful when inscribing the Circle within a regular polygon.

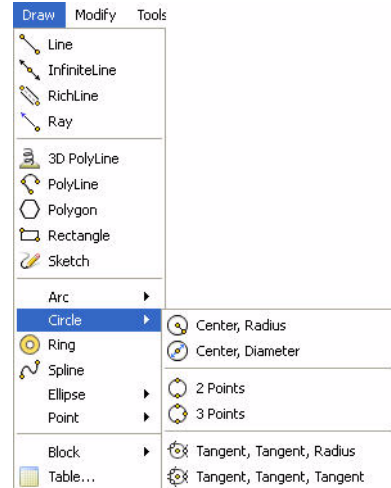

### NOTE:

When you specify a point coordinate as the diameter of a circle, DraftSight calculates the distance from the center of the circle to the specified point.

The available **Arc** commands are:

- **3 Points:** click the graphics area to define the start point of the Arc. Click the endpoint to define the Arc.
- **Start, Center, Angle:** click the start point and center point in the graphics area, and then enter the value of the Arc tangent angle from its chord.
- **Start, Center, End:** click the start point, the center point, and the endpoint in the graphics area.
- **Start, Center, Length:** click the start point and center point in the graphics area, and then enter the value of the Arc chord length. Click the required Points in the graphics area or enter the option values at the command line prompt.
- **Start, End, Angle:** click the start point and endpoint in the graphics area, and enter the positive or negative value of the angle from the chord to the tangent to the start point.
- **Start, End Direction:** click the start point, endpoint, and tangent direction from the start point in the graphics area. Click the required Points

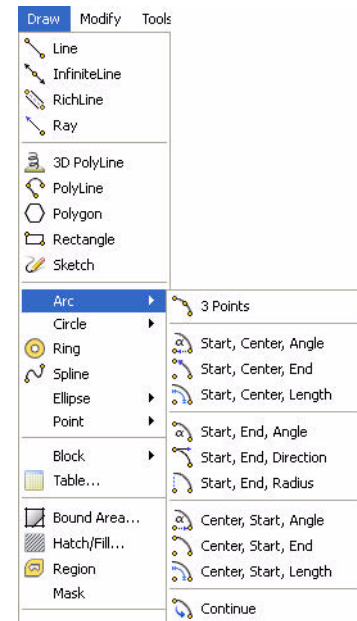

- in the graphics area or enter the option values at the Command Line prompt.
- **Start, End, Radius:** click the start point and endpoint in the graphics area, and then enter the value of the Arc tangent angle from its chord.
- **Center, Start, Angle:** similar to the Start, Center, Angle command except the first Point selected is the center point or the Arc rather than the start point.
- **Center, Start, End:** similar to the Start, Center, End command except the first Point selected is the center point of the Arc rather than the start point.
- **Center, Start, Length:** similar to the Start, Center, Length command except the first Point selected is the center point of the Arc rather than the start point.
- **Continue:** click a Line, PolyLine, or Arc entity in the graphics area. Click the Arc endpoint in the graphics area.

## Entity Selection

Many of DraftSight's modify and drafting commands prompt you to select one or more entities. When you select one or more entities, DraftSight highlights them by displaying dashed Lines (if no command is active, the Lines will also show the EGrips (blue blocks)). There are many different ways of selecting entities. We will discuss and apply:

Window Select and Crossing select.

## Window Select

The Window select method allows you to select more than one drawing entity in a defined area at a time. You define this area by specifying two corner points. Only the entities that lie completely within the rectangle will be selected.

### 6 Window Select Entities.

Click a position above the top Horizontal Line.

Specify opposite corner:

Drag downward and to the right to create a rectangular area as illustrated.

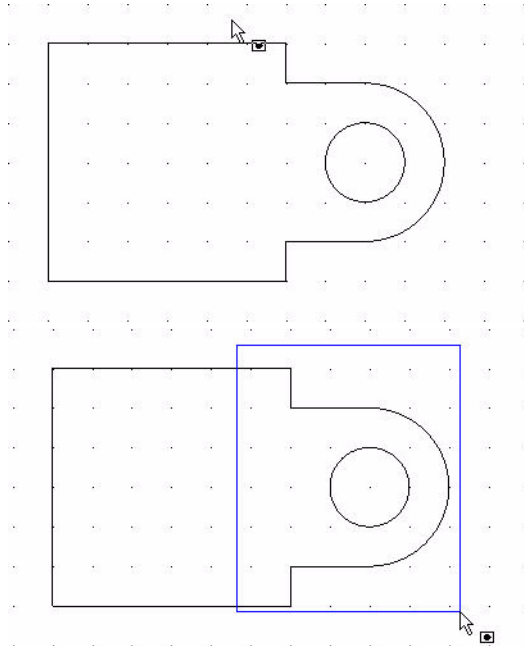



Click a position below the bottom Horizontal Line to the right of the Arc. The selected entities inside the window are displayed with dashed Lines and blue squares (EGrips).

- 7 Undo the Window Selection.**  
Press **Esc** or **Enter** to exit.

### Crossing Select

The Crossing select method allows you to select all entities that are contained completely or partially within the rectangular area. You define this area by specifying two corner points.

- 8 Window Cross Select Entities**  
Click a position below the bottom Horizontal Line to the right of the Arc.

Specify opposite corner:

Drag upward and to the center point of the Circle.

Click the center point of the Circle. All entities that are inside the window and all entities that crosses are selected window and are displayed with dashed Lines and blue squares.

- 9 Undo the Selection.**  
Press **Esc** or **Enter** to exit.

### Delete Command

#### Multiple Entities

The Delete  command provides the ability to remove selected entities while creating, editing, or detailing drawings.

- 10 Turn Snap Off.**  
Click the **Snap** button from the Status bar. The command window displays:  
<Snap Off>.

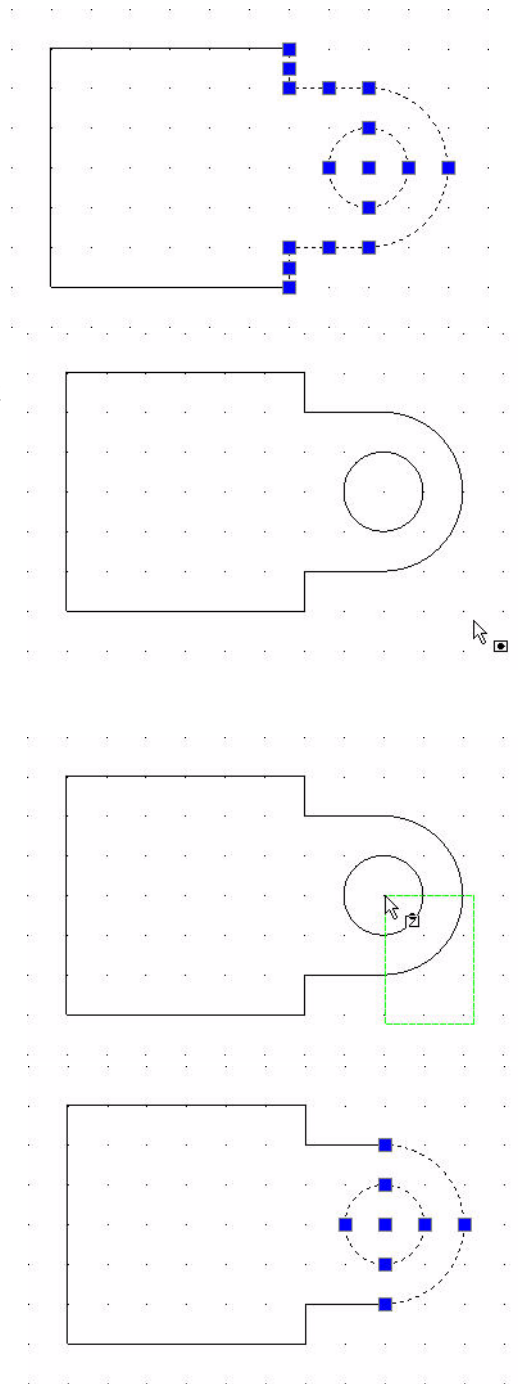

**NOTE:** With **Snap** on, the cursor can only select Points positioned directly on the Snap Grid.

- 1 Click **Delete**  on the Modify toolbar.  
Specify entities>>
- 2 Click the circumference of the Arc and Circle in the drawing.  
The selected Line becomes highlighted by turning dotted

1 found, 2 total

Specify entities>>↵

The entities are removed.

- 3 **Save the Drawing.**  
Click the **Save** icon  on the Standard toolbar.

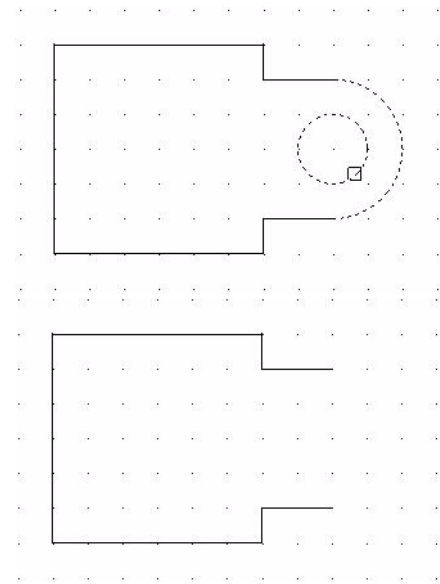

### Move Command

The **Move**  command repositions drawing entities within the coordinate system without changing the orientation or size.

### Multiple Entities

- 1 **Move Multiple Entities.**  
Click the **Move** icon  on the Modify toolbar.  
Specify entities>>

Window select the drawing entities. Click a position above the top Horizontal Line to the left of the Vertical Line.

Specify opposite corner:  
Drag downward and to the right.

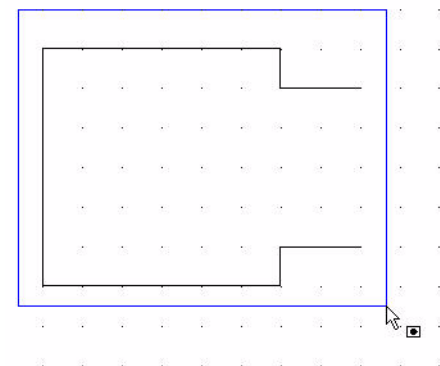

Click a position below the bottom Horizontal Line.  
The selected entities inside the window are displayed.

7 found, 7 total

Specify entities» ↵

Default: Displacement:

Specify from point>>

Click the lower left corner end point.

Options: *Enter from point as displacement*  
or

Specify destination>>

Move three grid units to the right.

Move three grid units upward.

Click a position to move all selected entities.

### Single Entity.

#### 1 Select a Single Entity.

Click the bottom Horizontal Line.

Click the **Move** icon  on the Modify toolbar.

Default: Displacement

Options: Displacement or

Specify from point>>

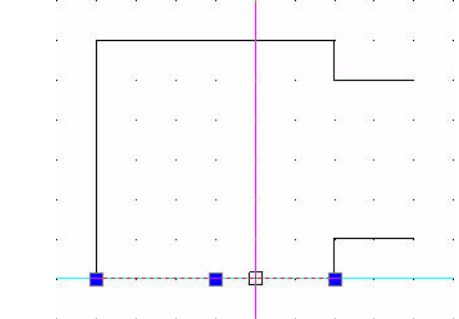
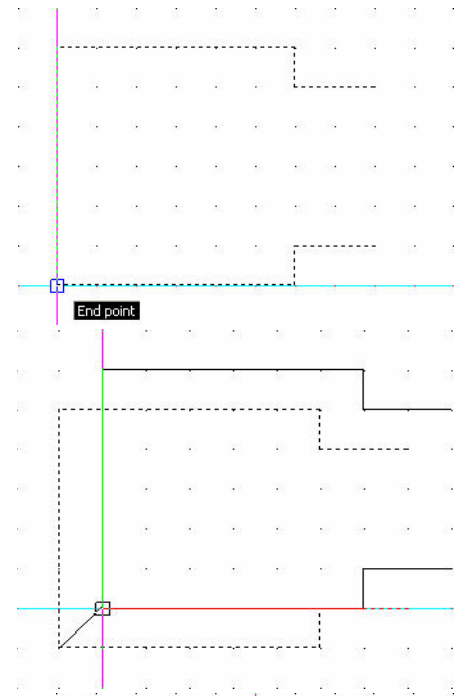
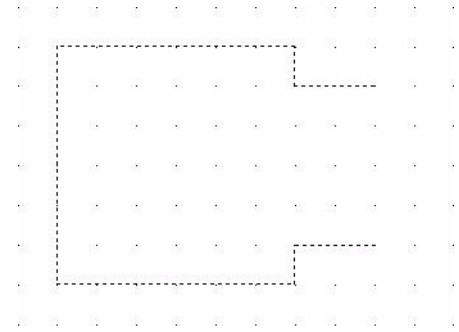

Click two grid units below the mid point of the bottom Horizontal Line.

Options: *Enter from point as displacement or Specify destination>>*

Move the selected horizontal linear segment **three grid units** downward as illustrated.

Click a position to move the selected entity.

## 2 Save the Drawing.

Click the **Save** icon  on the Standard toolbar.

## 3 Close the Drawing.

Click **File, Close** from the Main Menu.

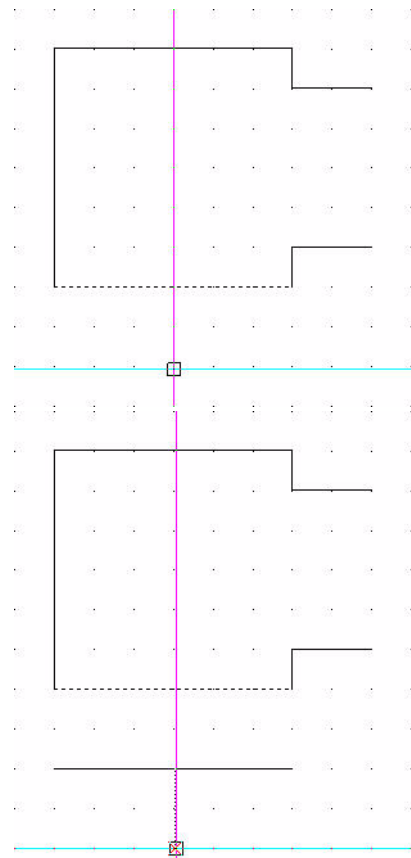

### NOTE:

To use the **Undo** command, click the Undo icon on the Standard toolbar or type **U** at the command prompt.

Use the **Undo** command to withdraw the last command. You can repeat undo until all steps in the undo list have been canceled, indicated by the message Nothing to undo in the Command prompt.

## Creating a New Drawing

### 1 Create a New Drawing

Click the **New** icon  on the Standard toolbar. The **Select Template** dialog box is displayed



### TIP:

You can also click **File, New** from the Main Menu to create a new drawing.

## Drawing Template

Drawing templates act as a basis for your finished work and set up the required drawing environment. Using templates saves time because you can reuse the elements and settings of an already existing drawing.

### 2 Select a Default Drawing Template.

Select `standard.dwt` from the **Specify Template** dialog box.

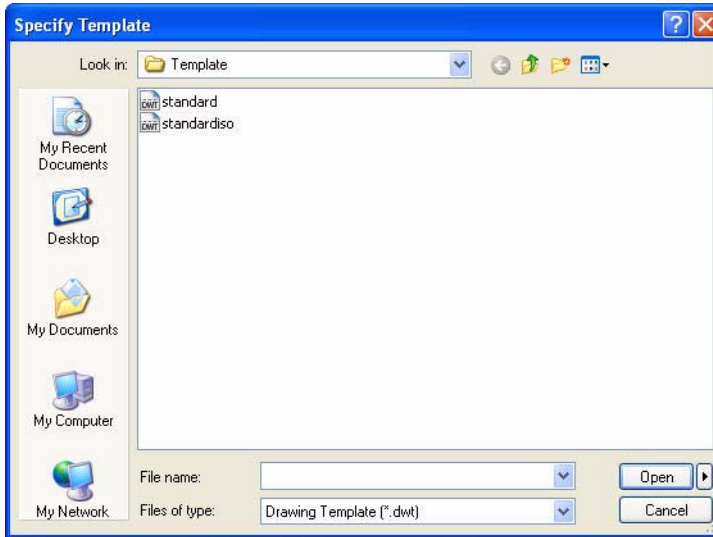

### 3 Click Open.



## Set the Drawing Environment

Set **System Units**, drawing **Boundary**, **Snap** and **Grid**. These settings are stored in your default drawing template.

### Set Drawing Unit System

The **Unit System** section of the **Options - Drafting Settings** dialog box, provides the ability to set: **Base Angle**, **Length Type** and **Precision**, **Angle Type** and **Precision**, as well as **Units scale** for the drawing.

Five different units systems are available:

- Scientific
- Decimal
- Engineering
- Architectural
- Fractional

The default units system is the Decimal system and can be applied to either English (inches) or metric values (millimeters).



**4 Set Linear Length Precision.**

The **Unit System** section of the **Options - Drawing Settings** dialog box allows you to set the linear and angular unit formats.

Click **Format, Unit System...** from the Main Menu.

The **Unit System** portion of the **Options - Drawing Settings** dialog box is displayed.

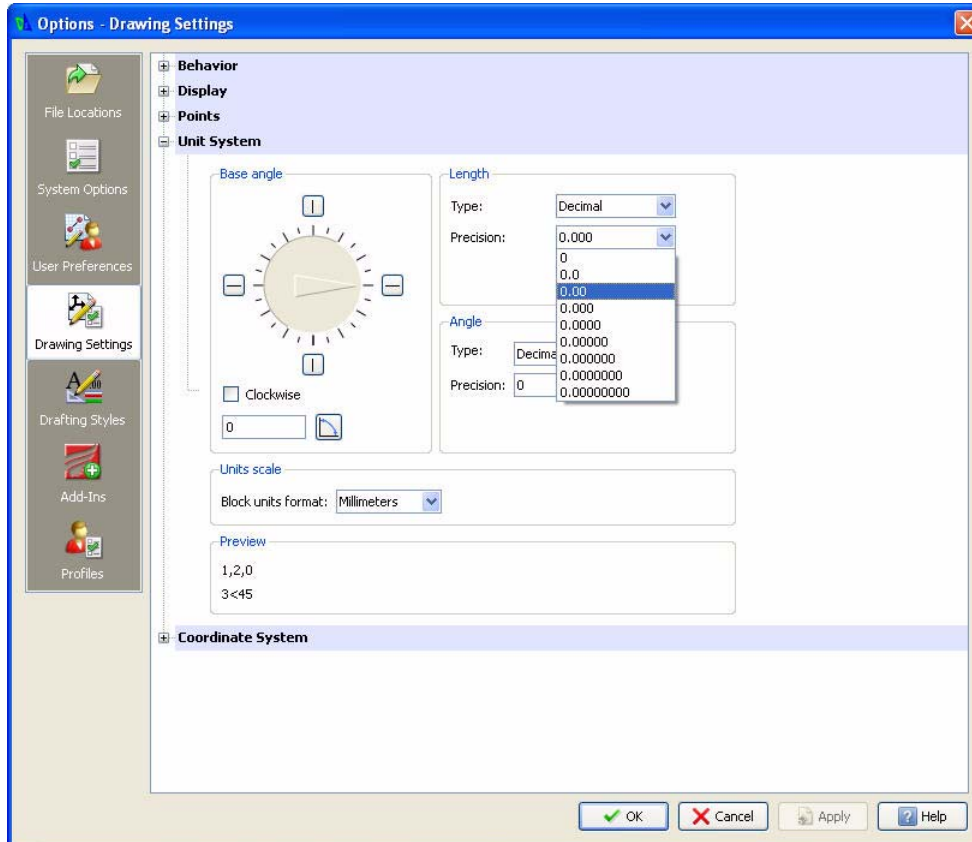

Click **0.00** for **Precision** in the **Length** section of the dialog box.

**5 Set Linear Units Scale.**

The **Units scale** section of the **Unit System** dialog box allows you to set the linear and angular unit formats.

Click **Millimeters** for **Block units format** in the **Units scale** section of the dialog box.

Click **OK**.

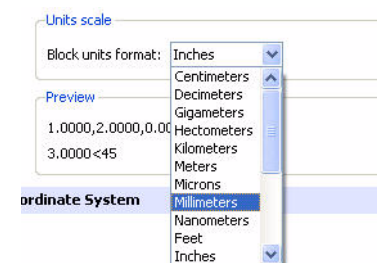

**Set Drawing Boundary**

The Drawing Boundary defines the extent of the grid display and restricts the graphics area. The Drawing Boundary can be helpful for printing/plotting; if you set your graphics area so that it scales directly to the default drawing sheet.

Drawing Boundary does not affect the display on the screen. Boundaries are expressed as a pair of Points in the World Coordinate System (WCS), a lower left and an upper right limit.

For example, to set limits for an A4 (metric) vertical sheet size, set the lower left as 0,0 and upper right as 210,297.

Usually drawing boundaries are relative to the paper size to be used when printing/plotting a drawing.

Default drawing sheet sizes - Millimeters are:

- A4 - 210 x 297
- A3 - 297 x 420
- A2 - 420 x 594
- A1 - 594 x 841
- A0 - 841 x 1189

Default drawing sheet sizes - Inches are:

- A - 8.5 x 11.0
- B - 11.0 x 17.0
- C - 17.0 x 22.0
- D - 22.0 x 34.0
- E - 34.0 x 44.0

In the next section, set the drawing boundary to use a horizontal A4 default drawing sheet.

## 6 Set Drawing Boundary.

Click **Format, Drawing Boundary** from the Menu bar.

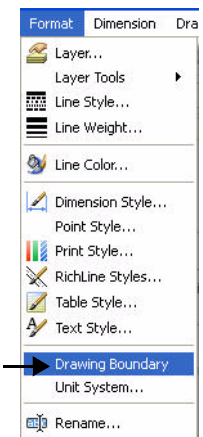

Default: (0.00, 0.00)

Options: Off, ON or

Specify lower left corner» ↵

Default: (12.00, 9.00)

Specify upper right corner» **297,210** ↵



Set Snap and Grid

The Snap is an invisible grid in the graphics area. With Snap activated, the cursor can only select Points positioned directly on the snap grid. When you Point to the drawing, startpoints, endpoints, center points, and other specific Points are exactly on a Point of the snap grid.

The Grid is a pattern of evenly spaced dots that serve as a visual distance reference. The Grid is not part of the drawing file and does not appear in the printed output.

You can set the Grid to span the graphics area or limit it to the extents of the drawing.

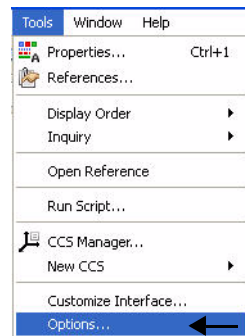

**NOTE:** The Snap and grid follow the axis of the coordinate system.

7 Set Snap and Grid.

Click **Tools, Options** from the Main Menu.

The **Options** dialog box is displayed.

Click the **User Preferences** tab.

Expand **Drafting Options, Pointer Control** and **Snap Settings**.

Click the **Enable Snap <F9>** box.

Enter the value of **10** in the **Horizontal Snap spacing** box. Press the Tab key The **Vertical Snap spacing** box is updated.

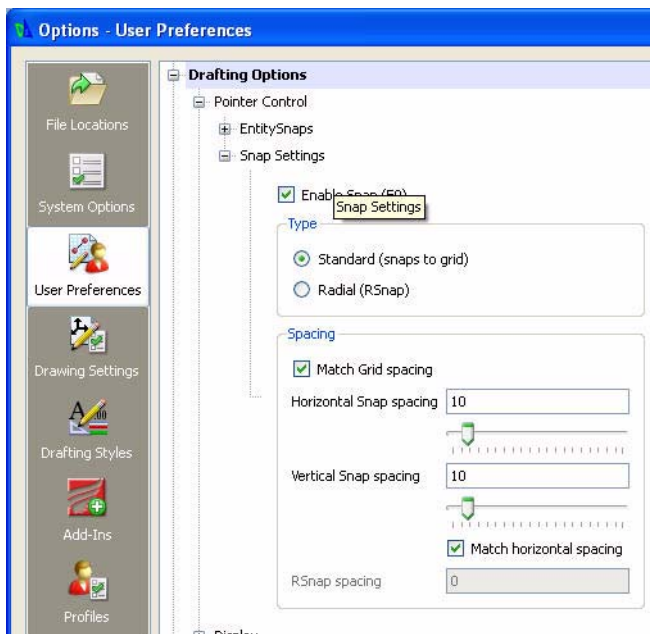





### Expand **Display** and **Grid Settings**

Click the **Enable Grid** <F7> box and the **Match Snap Spacing** box. The **Horizontal display spacing** value and the **Vertical display spacing** value will be set to **10.00**.

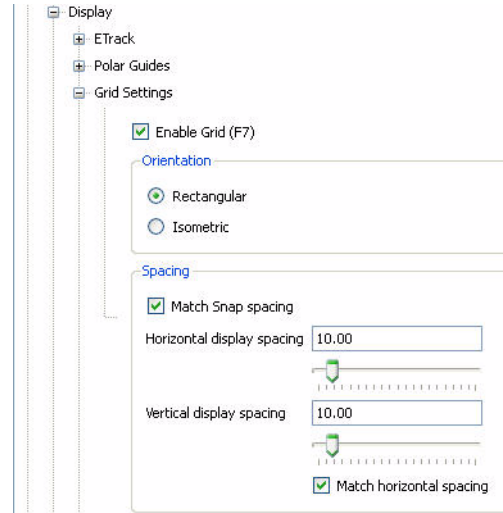
Click **OK**.



### Zoom Bounds

The **Zoom Bounds**  tool provides the ability to adjust the display so that all entities in the drawing are displayed to be as large as possible.

#### 8 Display the Drawing with the New Boundary.

Drawing boundaries need to be used to adjusted to the view.

Select **View, Zoom, Bounds**  from the Main Menu.

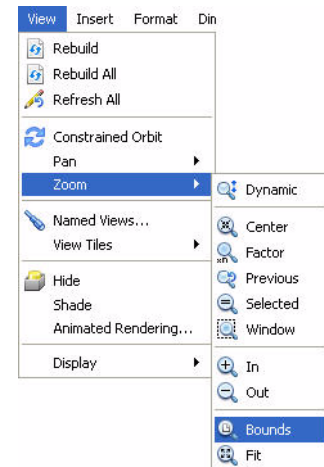

### Absolute and Relative Coordinates

In this manual, we will only deal with the 2D functionality of DraftSight.

All drawings are based on a Cartesian coordinate system in which two perpendicular axes are used: the X and Y axis. All axis originate in the origin Point of the coordinate system. The X axis and Y axis define a horizontal plane.

In the Cartesian coordinate format, a Point is defined by its distances in the XY plane. These distances are called the XY coordinates of a Point. When you draw in two dimensions, you specify Points only on the XY plane. In CAD, the fixed Cartesian coordinate system is called the World Coordinate System (WCS). New drawings are based in the WCS.

Enter coordinates as absolute or relative values.

To specify the Point coordinates with respect to the previous Point (relative coordinate input), type the @ character in front of the coordinate values.

### Absolute Coordinates

To specify absolute coordinates:

Type of Coordinate	Input	Example
Cartesian	X,Y	30,60
Polar	distance<angle	75<45

Enter a command requiring coordinates, for example:

**:Line.**

Specify the X and Y coordinates separated by a comma. **30,60**

Specify subsequent coordinates to complete the command. **35, 82**

### Relative Coordinates

Type of Coordinate	Input	Example
Cartesian	@deltaX,deltaY	@30,60
Polar	@relative_distance<angle	@75<45

To specify relative coordinates: Enter a command requiring coordinates. Specify the first Point. **0,0**

To specify the second Point with respect to the first Point, type the @ character in front of the coordinate values. **@30,60**

### Entering Keyboard Input

When you enter data using the keyboard, your data is precise. With keyboard input, you can construct drawing entities with exact dimensions or with exact placement in the coordinate system.

Values for distances, straight Lines, and other linear quantities are specified in drawing units. Angle values are specified in degrees.

Methods and syntax to use in this book:

- Interactive method: use the cursor to select on the graphics area
- Absolute coordinate (Format: X, Y) method: enter the X and Y coordinates to locate the Point on the active coordinate system relative to the origin.
- Relative rectangular coordinates (Format: @X,Y) method: enter the X and Y coordinates relative to the last Point
- Direct Distance method: specify the second Point by moving the cursor to indicate direction. Enter distance.

- Relative polar coordinates (Format: @Distance<angle) method: enter a distance and angle relative to the last Point.
- Periods: enter periods for decimal points.
- Commas: enter commas to separate the values for the axes, for example **0,2.1**
- < (less than): use the < (less than) sign before angle values, for example, <**30** represents a 30 degree angle.

**NOTE:**

You can type the Command name **Line**, or click the Line icon on the Draw toolbar.

Example of an input sequence using the keyboard:

: **Line** ↵

Options: Segments or

Specify start point>> **40,40** ↵

Options: Segments, Undo, *Enter to exit* or

Specify next point>> **120,40** ↵

Options: Segments, Undo, *Enter to exit* or

Specify next point>> **120,80** ↵

Options: Segments, Undo, *Enter to exit* or

Specify next point>> ↵

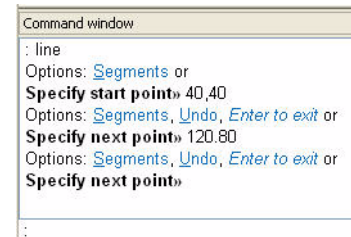
**NOTE:**

Commands in DraftSight are not case sensitive.

### Draw a Rectangle Using Absolute Coordinates

Draw a 60,40 rectangle using the **Line** icon  on the Draw toolbar starting at the coordinate **30,30** using absolute coordinates.

**NOTE:**

A rectangle drawn using the **Rectangle** command is considered to be a single entity.

If the same size rectangle were drawn using the **Line** command, the resulting rectangle will be considered four individual unrelated Lines.

**9 Draw the First Shape.**

Click the **Line** icon  on the Draw toolbar.

Enter coordinates in the Command prompt. View the command window area, near the bottom of the graphics area.

Options: Segment or

Specify Start point>> **30,30**↵

Options: Segments, Undo, *Enter to exit* or

Specify next point>> **90,30**↵

Options: Segments, Undo, *Enter to exit* or

Specify next point>>**90,70**↵

Options: Segments, Undo, Close, *Enter to exit* or

Specify next point>>**30,70**↵

Options: Segments, Undo, Close, *Enter to exit* or

Specify next point>>**c**↵

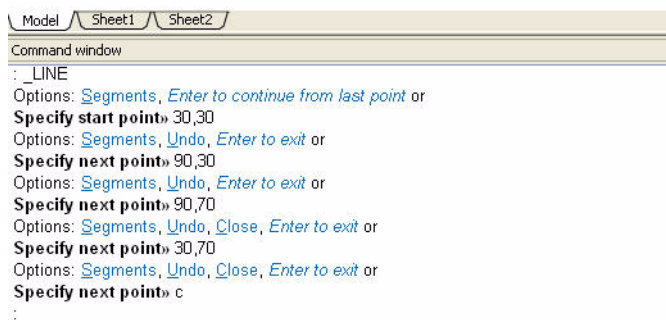
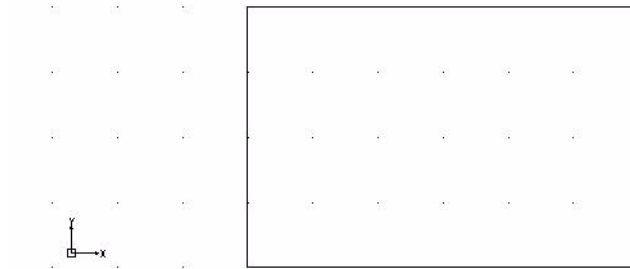

**NOTE:** The **C** option in the command closes the profile and ends the command.

**10 Save the Drawing.**

Click **File, Save As...** from the Main Menu.

Enter File name: Lesson 1-3.

Click **Save**.

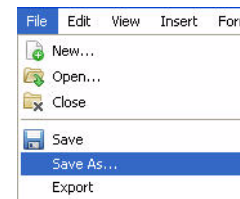

## Draw the Second Shape Using Relative Coordinates

Draw a five sided shape using the **Line** icon  on the Draw toolbar starting at the absolute coordinate **120,30** and using relative coordinates to complete the shape.

### 11 Draw the Five Sided Shape.

Click the **Line** icon  on the Draw toolbar.

Enter coordinates in the Command prompt.

Options: Segments or

Specify Start point>>**120,30** ↵

Options: Segments, Undo, *Enter to exit* or

Specify next point>>**@50,0** ↵

Options: Segments, Undo, Close, *Enter to exit* or

Specify next point>>**@0,40** ↵

Options: Segments, Undo, Close, *Enter to exit* or

Specify next point>>**@50<120** ↵

Options: Segments, Undo, Close, *Enter to exit* or

Specify next point>>**@-10,0** ↵

Options: Segments, Undo, Close, *Enter to exit* or

Specify next point>>**c** ↵

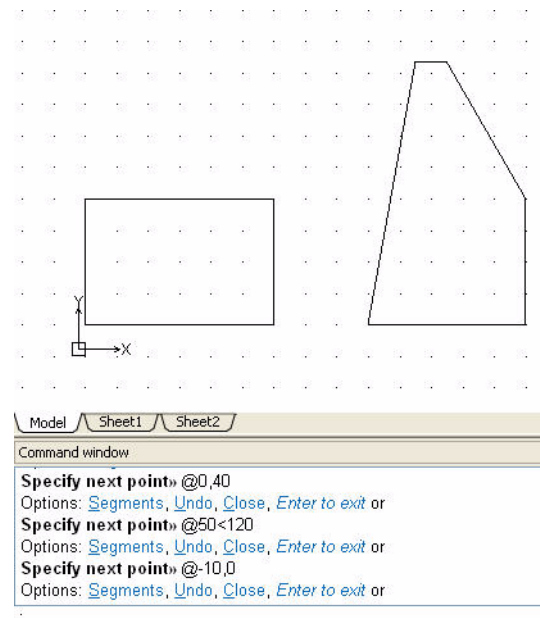

#### NOTE:

If you enter an incorrect coordinate, press the **U** key to **Undo** the last coordinate in the command.

### Draw the Third Shape Using Relative and Absolute Coordinates

Draw the third shape using the **Line** icon  on the Draw toolbar starting at the absolute coordinate **30,120** and using relative coordinates and absolute coordinates to complete the shape.

#### 12 Draw the Third Shape.

Click the **Line** icon  on the Draw toolbar.

Enter coordinates at the Command prompt.

Options: Segments or

Specify Start point>>**30,120** ↵

Options: Segments, Undo, *Enter to exit* or

Specify next point>>**@50,0** ↵

Options: Segments, Undo, *Close, Enter to exit* or

Specify next point>>**@0,20** ↵

Options: Segments, Undo, *Close, Enter to exit* or

Specify next point>>**@40<0** ↵

Options: Segments, Undo, *Close, Enter to exit* or

Specify next point>>**@0,-20** ↵

Options: Segments, Undo, *Close, Enter to exit* or

Specify next point>>**@30<0** ↵

Options: Segments, Undo, *Close, Enter to exit* or

Specify next point>>**@40<90** ↵

Options: Segments, Undo, *Close, Enter to exit* or

Specify next point>>**@20<0** ↵

Options: Segments, Undo, *Close, Enter to exit* or

Specify next point>>**@30<90** ↵

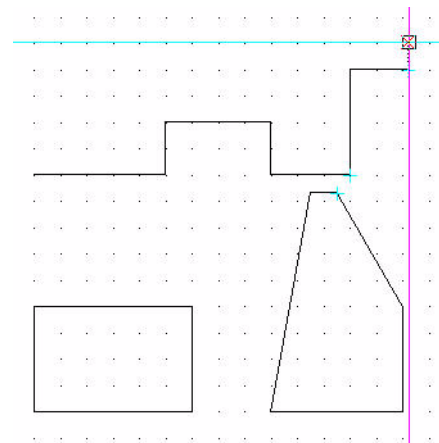

Options: Segments, Undo, Close, *Enter to exit* or

Specify next point>>@-40,0.↓

Options: Segments, Undo, Close,  
*Enter to exit* or

Specify next point>>@-20,-20.↓

Options: Segments, Undo, Close,  
*Enter to exit* or

Specify next point>>@-20,20.↓

Options: Segments, Undo, Close,  
*Enter to exit* or

Specify next point>>@-25,0.↓

Options: Segments, Undo, Close,  
*Enter to exit* or

Specify next point>>c.↓

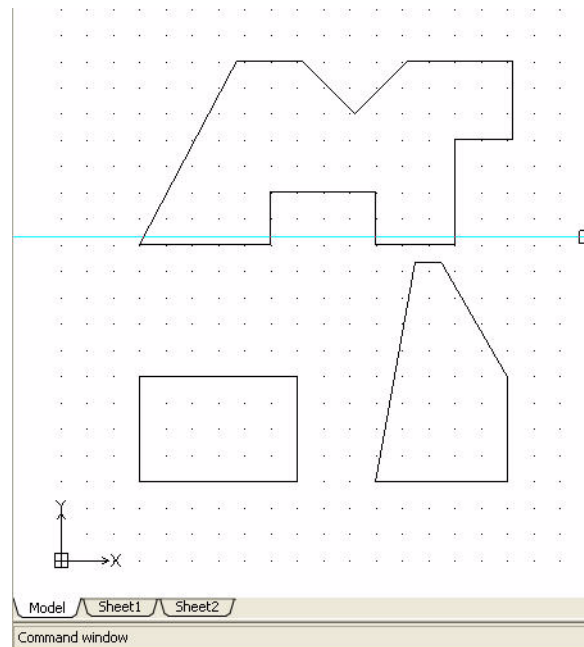

### 13 Save the Drawing.

Click the **Save** icon  on the Standard toolbar.

### Print Command

The **Print**  command provides the ability to print or plot an entire drawing sheet, or just a selected area of the sheet. You have the option to print in black and white (the default) or in color.

There are no complicated printing commands. Click the **Print** icon  on the Standard toolbar or type **Print** at the Command prompt. The **Print - Model** dialog box is displayed.

Use the **Page Setup** section to set a previously defined print style or create a named print style based on what you set up in the dialog box.

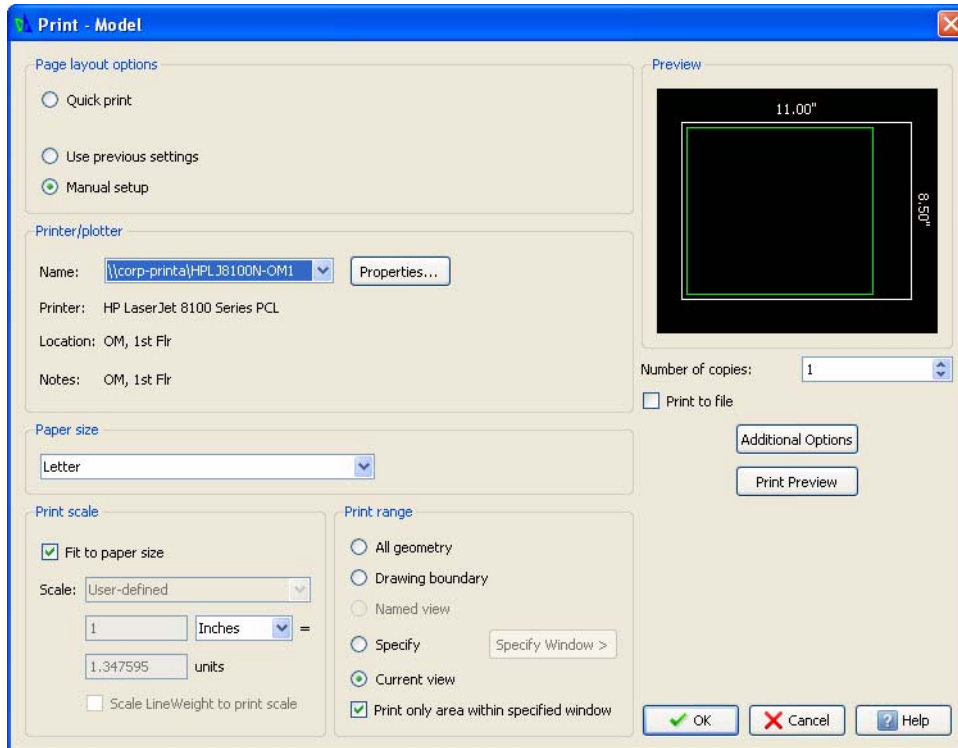

## Model Tab / Sheet Tabs

The DraftSight software provides the ability to work on your drawing in two different environments: Model or Sheet.

You can print your drawing from Model to any scale by specifying the print setup in the **Print - Model** dialog box.

Sheet, is a environment used for arranging various views of what was drawn in your Model. It represents the paper size which you set in the drawing environment.

You can apply different scales and specify different visibility for Layer in each floating ViewPort.

You can switch between Model and Sheet by selecting the appropriate tab provided at the bottom of the graphics area. Model can be accessed from the Model Tab. Selecting one of the available Sheet Tabs will access the sheet.

By default, two sheet tabs are created: `Sheet1` and `Sheet2`. You can rename these and if necessary create up to 255 additional sheet tabs. The names of the sheet tabs must be unique.

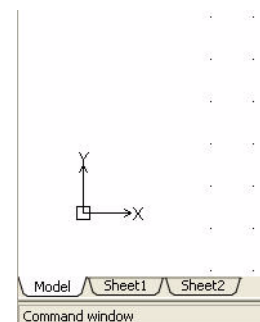



**14 Click the sheet1 tab**

This will open Sheet1

**15 Right click on the Sheet1 name**

This will open the Sheet Manager Dialog box.

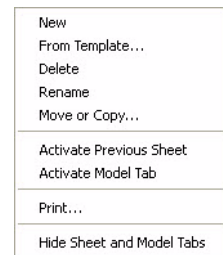
**16 Click the Print... option.**

Set your options.

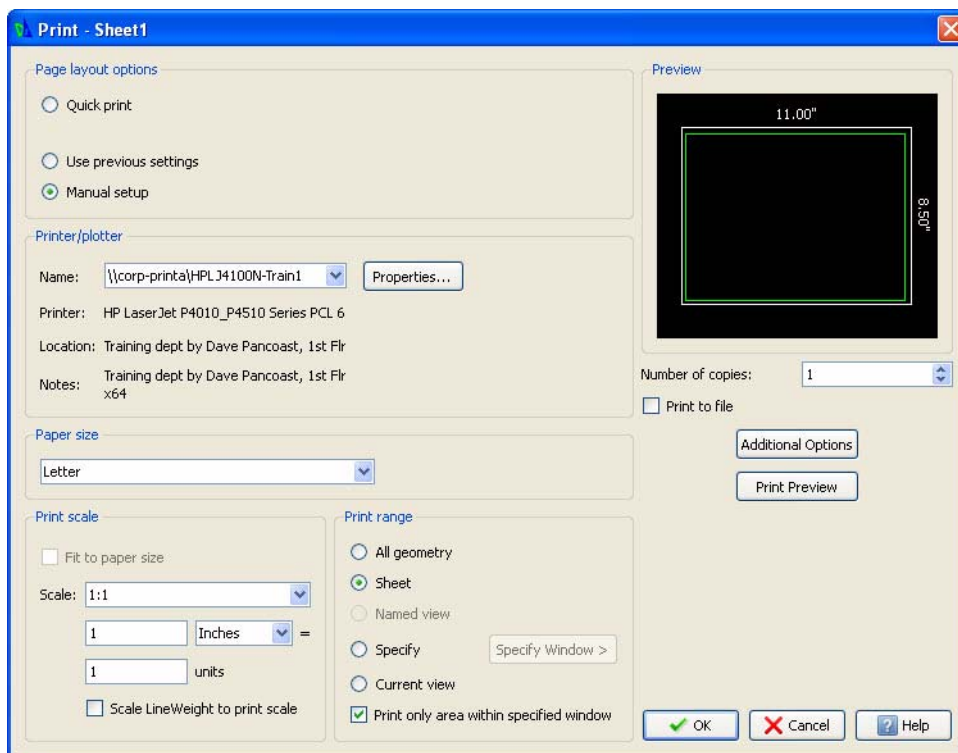
**Page setup options:**

- **Quick print:** Prints exactly what is on screen with the system default printer, default paper size, **Fit to paper size** selected and **Print range** set to **Current view**.
- **Use previous settings:** Repeats printing with the same setting you used for the previous printout.
- **Manual setup:** Allows you to determine the print settings.

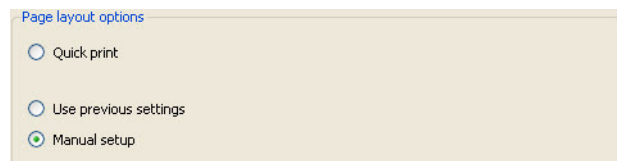

**Printer/plotter:**

- **Name:** Allows you to select an output device. Printers and plotters available on your system are listed. PDF, JPG, PNG and SVG are also listed. These built in plotters print to a file in the specified format.
- **Properties:** Allows you to set up the printer or plotter as needed in the dialog box provided by the printer's driver.

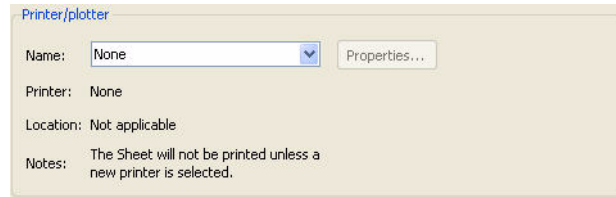

**TIP:** Select the **Help** button to explore the **Print- Model dialog** box in detail.

17 Select the **Cancel** button to return to the graphics area.

**Pan Commands**

The most basic functions that change drawing views are the **Pan** and **Zoom** commands. The **Pan** tools move the visible portion of the drawing in a specified direction. The **Pan** tools do not change the position or the magnification of drawings entities.

Pan allows you to view entities previously not visible because they were out of the viewing area. When panning, the scale of the view does not change, as it does when zooming.

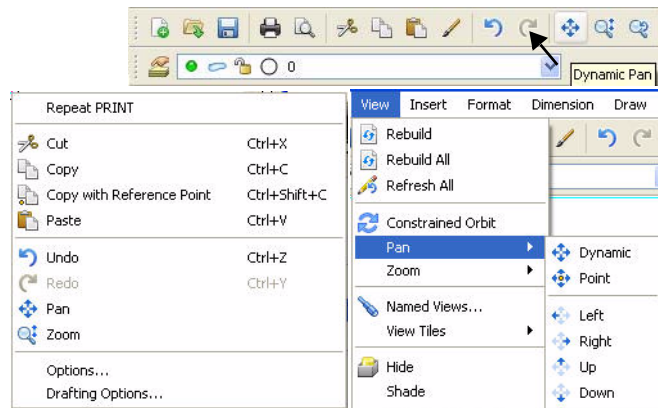

**NOTE:** When you use the Pan tool, it as if the camera, not the scene is moving.

Access various **Pan** tools from the Main Menu, drop-down menu in the Standard toolbar, or right-click in the graphics area.

- **Dynamic Pan:** allows you dynamically pan by moving the mouse pointer.
- **Point Pan:** use point pan to move the view of the drawing in any direction by pointing a displacement (vector). the size of the view remains the same.
- You define the displacement by identifying two Points. these Points determine a vector giving the distance and direction of the pan.

- **Left Pan:** when you pan left, the visible part of the drawing moves left.
- **Right Pan:** when you pan right, the visible part of the drawing moves right.
- **Up Pan:** when you pan up, the visible part of the drawing moves up.
- **Down Pan:** when you pan down, the visible part of the drawing moves down.

### 18 Apply Dynamic Pan.

Click the **Dynamic Pan** icon  on the Main Menu. The Pan icon of a hand is displayed.

Press **Esc** or **Enter** to exit.

Position the **Pan** icon  in the graphics area near the second drawing as shown.

Click and drag to the left.

Click and drag upwards.

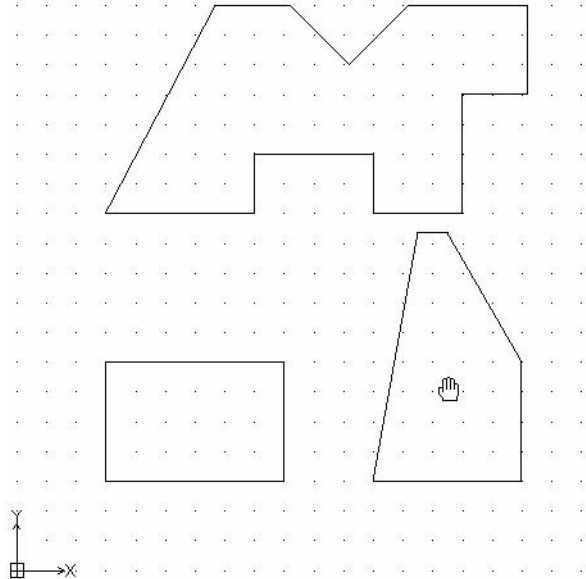

#### NOTE:

The scroll bars on the right and bottom of the graphics area, when activated can also be used to adjust the viewing for the drawing.

### 19 Exit Dynamic Pan.

Press **Esc** or **Enter** to exit.

### 20 Close the Active Drawing.

Click **File, Close** from the Main Menu.









#### NOTE:

Dimensions are inseted in Lesson 4.

## Correct Drafting Mistakes

DraftSight provides many tools to correct drafting mistakes. Correct mistakes using the following commands:

-  **Delete**: deletes any entity from your drawing. Use the **Delete** command to remove selected entities while creating, editing, or detailing drawings. Click the **Delete** icon  on the Modify toolbar or type **Delete** at the Command prompt.
-  **Undo**: use the **Undo** command to withdraw the last command. You can repeat undo until all steps in the undo list have been canceled, indicated by the message `Nothing to undo` in the Command prompt. Click the **Undo** icon  on the Standard toolbar or type **U** at the Command prompt.
-  **Redo**: the **Redo** command reverses a previous **Undo** operation. You can use the **Redo** command only if no other command has changed the drawing database since the last **Undo** command. Click the **Redo** icon  on the Standard toolbar or type **Redo** at the Command prompt.
- **Undelete**: use the **Undelete** command, like the **Undo** command, to restore entities that have been deleted by mistake. Also use **Undelete** to restore entities after creating a Block using the **MakeBlock** command. Type **Undelete** at the Command prompt.

## Lesson 2 DRAFTING TUTORIALS

When you complete this lesson, you will be able to:

- Create three new drawings with multiple Layers
- Use absolute coordinates the command prompt and status bar
- Utilize the Line, Circle (R & Ttr), Polygon, Rectangle, SimpleNote, Spline, and PolyLine Draw commands
- Apply the Copy, Rotate, Move, Trim, Fillet, Mirror, Chamfer, Offset, Edit PolyLine, and Pattern (circular & linear) Modify commands.
- Create a new Layer with properties
- Manage Layers in a drawing
- Move Entities to a different Layer

## Drafting Tutorials

During this lesson, you will create three drawings by inputting absolute coordinates at the Command prompt and the graphics area.

In the first drawing you will:

- Create three new Layers with custom properties: Object, Centerline, and Construction.
- Use the **Circle**, **Polygon**, **Line**, **Rectangle**, **SimpleNote**, **Spline** and **PolyLine** commands on the Draw toolbar.
- Apply the **Copy**, **Rotate**, **Trim**, **Fillet**, **Mirror**, and **Edit PolyLine** commands on the Modify toolbar,

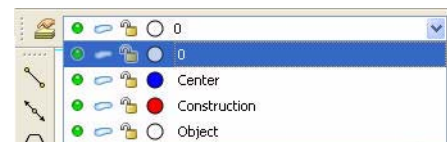
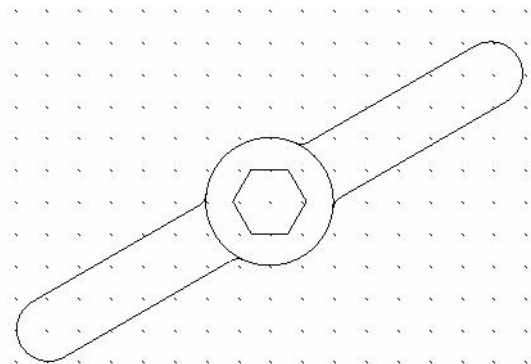

In the second drawing you will:

- Create three new Layers with custom properties: Object, Construction and Centerline.
- Use the **Rectangle**, and **Circle** commands on the Draw toolbar.
- Apply the **Pattern** command to create a circular and linear pattern along with the **Chamfer** command on the Modify toolbar.

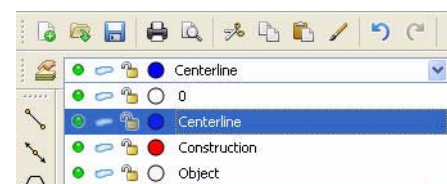
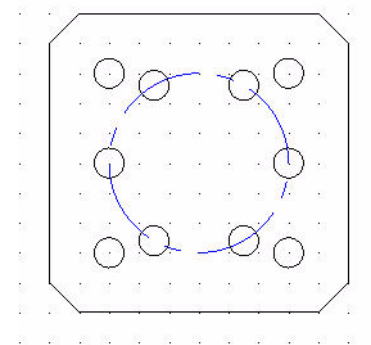

In the third drawing you will:

- Create two new Layers with custom properties: Object and Phantom.
- Use the **Circle (r)**, and **Circle (Ttr)** commands on the Draw toolbar.
- Apply the **Trim**, **Offset**, and **Pattern** (circular) commands on the Modify toolbar.

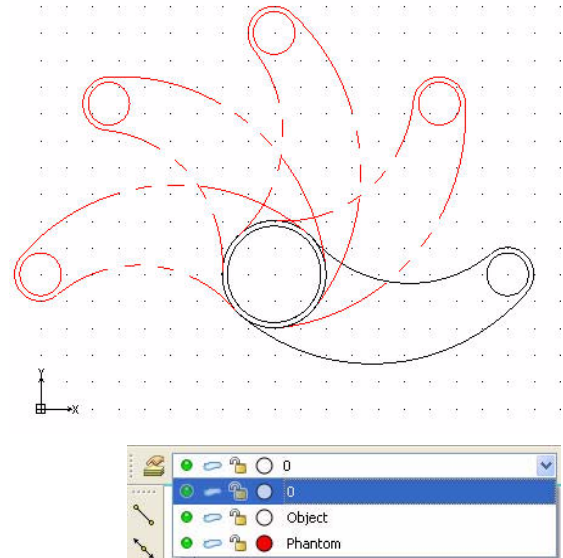

### Start a DraftSight Session

- 1 **Start a DraftSight session.**  
From the Windows Start menu, click **Start, All Programs, SolidWorks Corporation, DraftSight.**

### Create a New Drawing

- 2 **Create a new drawing.**  
Click the **New** icon  on the Standard toolbar. The **Select Template** dialog box is displayed.

### Drawing Template

- 3 **Select a Default Drawing Template.**  
Select **standard.dwt** from the **Specify Template** dialog box.
- 4 **Click Open.**



### Set the Drawing Environment

#### Drawing Unit System

The default units system is the Decimal system and can be applied to either English (inches) or metric values (millimeters).

- 5 **Set Linear Length Precision.**  
Click **Format, Unit System...** from the Main Menu.  
The **Unit System** section of the **Options - Drawing Settings** dialog box is displayed.  
Select **0.00** for **Length Precision**.
- 6 **Set Linear Units Scale.**  
The **Unit System** section of the **Options - Drawing Settings** dialog box allows you to set the linear and angular unit formats.  
Click **Millimeters** for **Block units format** in the **Units scale** section of the dialog box.  
Click **OK**.

## Drawing Boundary

Use a horizontal A4 default drawing sheet.

### 1 Set Drawing Boundary.

Click **Format, Drawing Boundary** from the Main Menu.

Default: (0.00, 0.00)

Options: Off, ON or

Specify lower left corner»↵

Default: (12.00, 9.00)

Specify upper right corner» **297,210** ↵

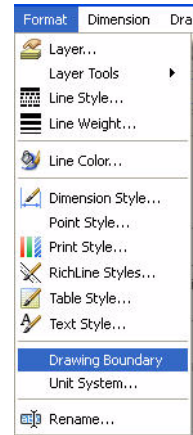

## Set Snap and Grid

In this section the Grid equals the Snap.

### 1 Set Snap and Grid.

Click **Tools, Options** from the Main Menu.

The **Options** dialog box is displayed.

Click the **User Preferences** tab.

Expand **Drafting Options, Pointer Control** and **Snap Settings**.

Click the **Enable Snap <F9>** box.

Enter the value of **10** in the **Horizontal Snap spacing** box. Press the **Tab** key The **Vertical Snap spacing** box is updated.

Expand **Display** and **Grid Settings**.

Click the **Enable Grid <F7>** box and the **Match Snap Spacing** box. The **Horizontal display spacing** value and the **Vertical display spacing** value will be set to **10.00**.

Click **OK**.

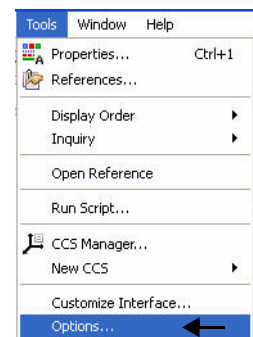

## Zoom Bounds

### 2 Display the Drawing with the New Boundary.

**Note:** Click **View, Zoom, Bounds**  on the Main Menu.

#### NOTE:

You can also select the **Zoom Bounds** icon on the Zoom toolbar if it is active or type the following at the command prompt:

**Zoom.**↵

Default: Dynamic

Options: Bounds, Center, Dynamic, Eit, Previous, SElected, *specify a scale factor (nX or nXP)* or

Specify first corner>> **B.**↵



## Working with Layers

Working with Layers is analogous to drawing manually using Layers of see-through media. Parts or portions - these might be functional portions, such as Construction Lines, - of one complete drawing are drawn on different 'media' that, imposed on top of one another, form the entire drawing.

Layers are useful in separating entities, such as parts or sub-assemblies, or structural components, such as pipe sizes or building materials. They also serve to separate elements such as Construction Lines, Centerlines, Outlines, and Dimensions, or items that are to be placed in a group, such as foliage in an architectural drawing.

When you use Layers, you have a clearer construction of the drawing and better control over the drawing.

### Layer 0: The Default Layer

The default Layer is called 0. It is automatically generated by DraftSight when a new drawing is created. This is your active Layer which is shown, un-suppressed and unlocked. The color 7 (white on a black background, or black on a white background) and the LineStyle Continuous are automatically established for this Layer.

**NOTE:** You cannot erase or rename the default layer (layer 0).

**TIP:** It is good practice to avoid using the default layer as a drawing tool.

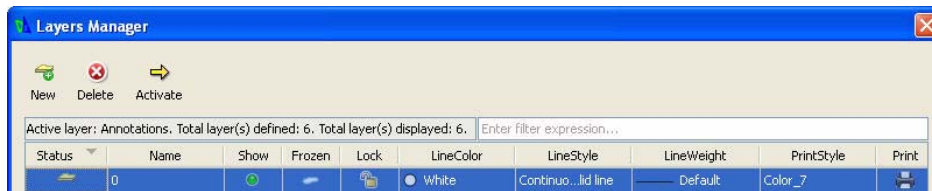

### Layer Properties

Each Layer has a **Status**, **Name**, **Show**, **Frozen**, **Lock**, **LineColor**, **LineStyle**, **LineWeight**, **PrintStyle** **Print**, and **Description** associated with it when it is created. Anything drawn on a Layer will be drawn with that Layer's properties.

There are other Layer properties that allow you to switch between different states.

These are **Show/Hide**, **Frozen/UnFrozen**, and **Lock/Unlock**.

The Layer and its properties are saved with the drawing.

Layer properties include:

- **Status:** one Layer in each drawing is the active Layer. In the Layer Properties Manager this is indicated in the Status column. All new entities are placed on this Layer.
- **Name:** each Layer has a distinctive name to identify it. Names can contain letters, numbers, or special characters like under scores and dollar signs.

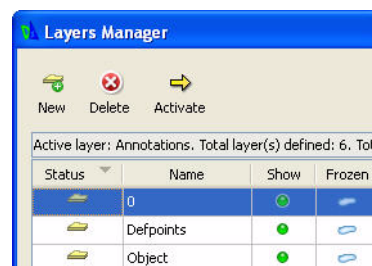

- **Show/Hide:** An advantage of working with Layers is that it aids in visualizing the part or drawing. You can improve the clarity of a drawing by choosing Layer properly and hiding drawing entities. The show icon indicates whether the Layer is shown or hidden. You can turn each Layer on or off independently.
- **Frozen:** These properties control the visibility and the influence of entities within the Layer. A Frozen Layer is invisible and protected and thus impossible to change. A Frozen Layer is not included when you regenerate a drawing. When working with complex drawings, freezing unneeded Layers can increase performance. When you un-freeze a Layer, it becomes visible and you can make changes to it. You cannot suppress the active Layer of a drawing.

- **Lock/Unlock:** You can lock Layers so the entities on the Layer cannot be changed. The locked state prevents unintentional modification. When a Layer is locked, you cannot change, add, or delete entities from the Layer. You must change the status to unlocked if you want to work with the entities on this Layer. You can draw new entities on locked Layers, but it is not possible to work with them further. A locked Layer may be designated active, visible or invisible, or frozen or unfrozen.

Frozen	Lock	LineColor	LineStyle
☐	🔒	● Red	CENTER ... _ _
☐	🔓	○ White	Continuo...lid line
☐	🔓	○ White	Continuo...lid line

- **LineColor:** When you start a new drawing, new Layers are automatically assigned the LineColor white. When you create a new Layer, the Layer adopts the LineColor of the new Layer. Entities you draw on the Layer appear in the assigned LineColor except those to which you assigned a LineColor with the LineColor command.

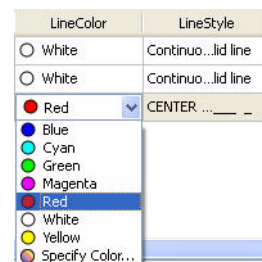

- **LineStyle:** A default LineStyle is assigned to a Line. If you do not choose another LineStyle, the LineStyle Continuous is automatically assigned. The chosen LineStyle is displayed in the Properties Palette.

LineStyle	LineWeight	PrintStyle
Continuo...lid line	— Default	Color_7
Continuo...lid line	— Default	Color_7
CENTER _ _ _	— Default	Color_1
Continuo...lid line		
CENTER ... _ _		
HIDDEN ... _ _ _		
Other...		

- **LineWeight:** You can set the **LineWeight** of the entities on the Layer. LineWeight affect the printed drawing only. The chosen LineWeight is displayed in the Properties Palette.
- **PrintStyle:** You can assign individual PrintStyles to Layers. The chosen PrintStyle is displayed in the Properties Palette.
-  **Print:** You can turn Layers on or off for printing / plotting.
- **Description:** You can enter a Layer description.

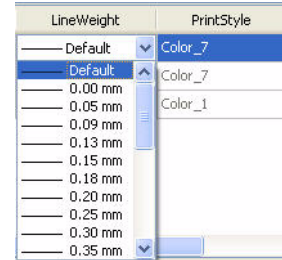

## Manage Layers

Use the **Layers Manager** icon  to create new Layers, designate active Layers, and set Layer properties.

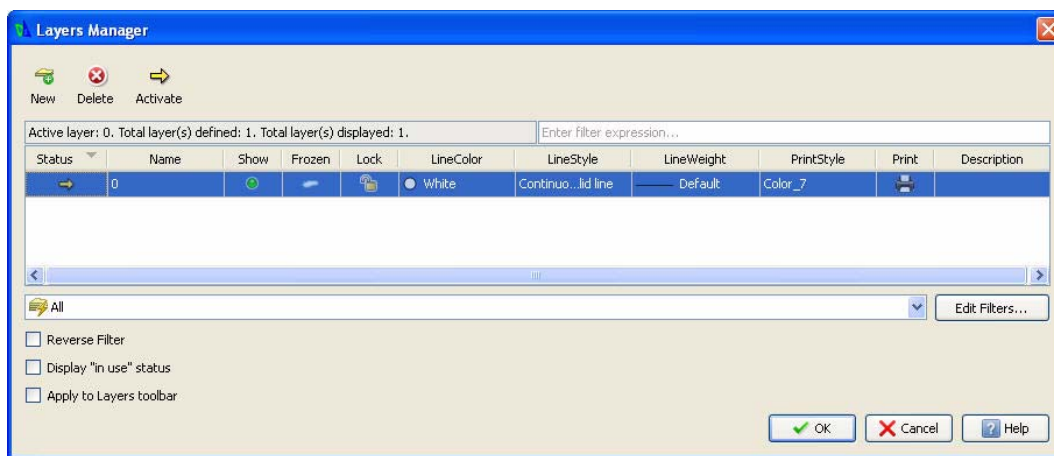

## Creating New Layers

You can create a new Layer any time. For efficiency, it is recommended that you plan the Layers to be used in advance and create them in a systematic manner.

To create a new Layer using the Layers Manager, click the **New Layer** icon . Type a Layer name, or press **Enter** to accept the existing default Layer name.

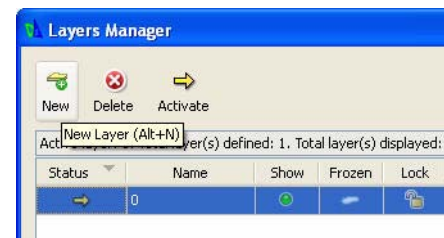

## Changing the Active Layer

To make a Layer active (current), select the Layer name from the **Name** cell, and then click **Activate** located at the top of the dialog box. Click **OK** from the pop-up box.



### Renaming a Layer

To rename a Layer in the Layer Properties Manager, double-click the **Name** cell of the Layer you want to rename. Type the **new name**, then press **Enter**.



### Controlling Layer Behavior

- **Show/Hide:** when a Layer is shown, it is visible. Hidden Layers are invisible. To show or hide a Layer in the Layer Properties Manager, double-click the **Show** icon in the Show cell that you want to change.
- **Frozen/UnFrozen:** in addition to turning the Layer off, you can freeze Layers. The Layers that are Frozen will not be visible in the view window, nor will they be printer. Frozen Layers are similar to Layers that are off (hidden). However, Layers that are simply hidden still go through screen regeneration each time the system regenerates your drawing, whereas the Layers that are suppress are not considered during screen regeneration.
- **Lock/Unlock:** controls the ability to edit entities on a Layer. When a Layer is locked, it is protected but visible. When a Layer is unlocked, it is unprotected and visible. To lock or unlock a Layer in the Layers Manager, double-click the **Lock** cell you want to change.

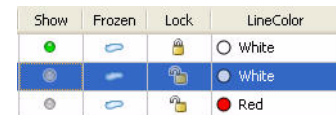
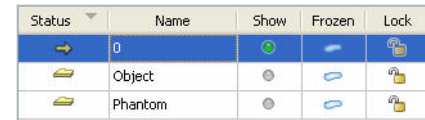

### Setting the LineColor

New Layers are automatically assigned the LineColor white. Entities you draw will appear in the assigned LineColor for that Layer except those to which you assigned a LineColor with the **LineColor** command.

To set a **LineColor** in the **Layers Manager**, double-click the **LineColor** cell you want to change. Select a **color** from the drop-down menu or click **Specify Color** for additional LineColor options.

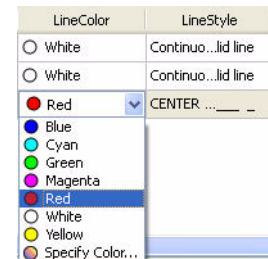

### Setting the Layer LineStyle

A LineStyle is a graphical symbol that has specific settings that make the Lines appear differently. Entities you draw will appear in the assigned LineStyle except those to which you set to another LineStyle.

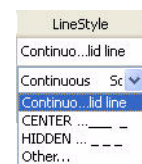

To set a Layer LineStyle, double-click the **LineStyle** cell and select the desired **LineStyle** or select **Other, Load** to load a new LineStyle from the **LineStyle Manager** dialog box.

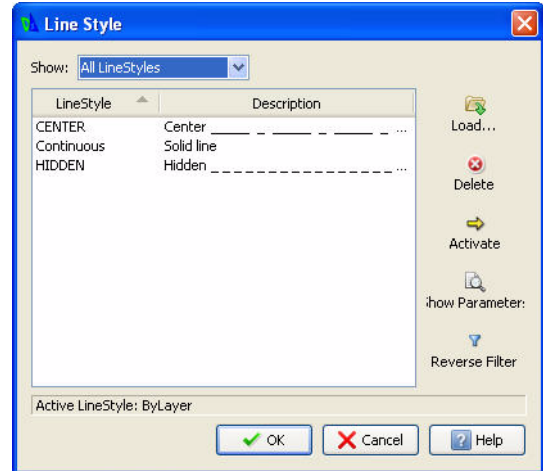

By setting the **LineStyle** to **ByLayer** in the properties toolbar all elements of this Layer will be drawn with the LineStyle that is set. Elements of the Layer that were drawn with a different LineStyle than the default LineStyle are not affected by the change.

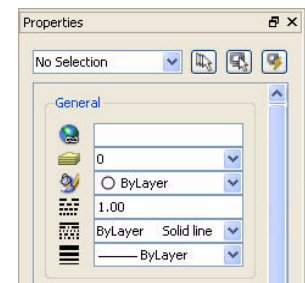
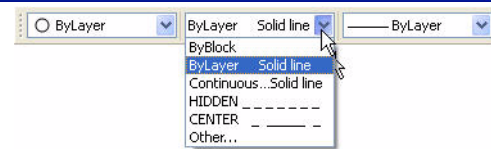

### Setting a Layer LineWeight

By default, DraftSight assigns the LineWeight of the currently selected Layer in the Layer list to the newly created Layer. To set the Layer LineWeight, double-click the **LineWeight** cell and select the desired option.

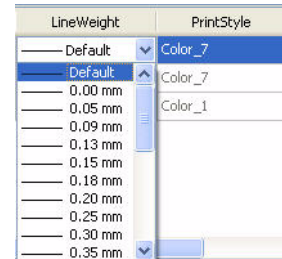

#### NOTE:

The display on the screen will not change. The LineWeight will only be visible on a printed drawing.

### Setting PrintStyle

PrintStyle is a collection of properties settings (such as **LineColor**, **LineStyle** and **LineWeight**) that can be assigned to a Layer or to individual entities. The chosen PrintStyle type is displayed in the Properties Palette.



### Setting Print

DraftSight allows you to turn Printing / Plotting on or off for visible Layers. Example, if a Layer contains Construction Lines that need not be printed, you can specify that the Layer is not printed. If you turn off printing for a Layer, the Layer is displayed but is not printed.

PrintStyle	Print	Description
Color_7		
Color_7		
Color_1		Customer XYZ

To change the setting for the printing of Layers, double-click the icon corresponding to the Layer name located in the **Print** column as shown.

### Setting Description

Double-click inside the desired cell under the **Description** column to enter a Layer description.

### Setting Filtering and Display Options

You can create filters that contain Layers you select. Grouping Layers this way establishes group filters. Two Layer group filters are predefined:

- All
- All Used Layers

### Create Three New Layers for the Drawing

In this section, you will create three new Layers called Object, Construction and Centerline. As well as apply custom properties.

#### 3 Create the first new Layer.

Click the **Layers Manager** icon  on the Layers toolbar

The **Layers Manager** dialog box is displayed.

**Note:** You can also click **Format, Layer** from the Main Menu to display the **Layers Manager** dialog box.

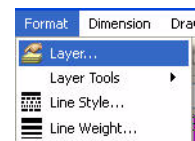

Click the **New Layer** icon.  The new default name is Layer 1.

Rename this layer **Object**

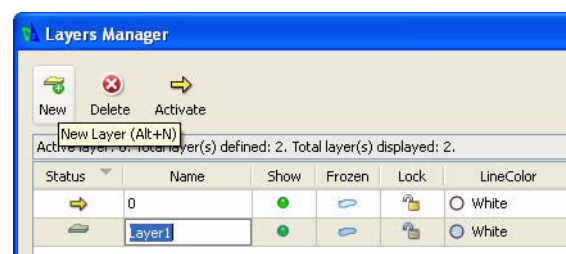

#### NOTE:

Double-click inside the Layer1 Name cell in order to rename if it is not active.

*Object* is the new Layer name.



The Object Layer will inherit all of the properties of the default Layer 0.

#### 4 Create the Second New Layer

Click the **New Layer** icon.  The new default name is Layer2.

Rename this Layer **Construction**.

*Construction* is the new Layer name.

#### 5 Set the Second Layer LineColor.

New Layers are automatically assigned the LineColor white.

Double-click the **LineColor** cell for the Construction Layer.

Click **Red**.

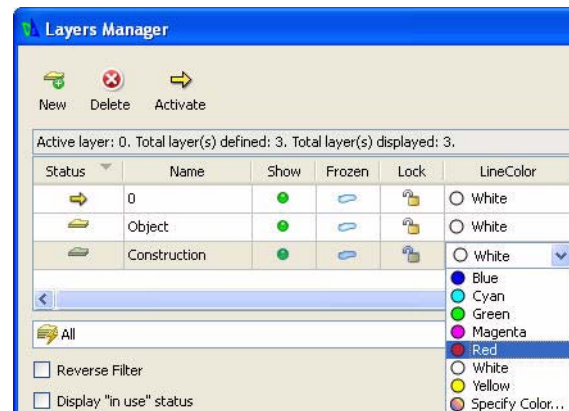
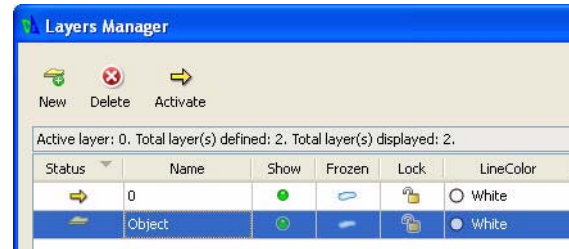

#### 6 Create the Second Layer LineStyle.

Create a MM HIDDEN **LineStyle**.

Double-click the **LineStyle** cell from the Construction Layer.

Click **Other**. The **LineStyle Manager** dialog box is displayed.

Click the **Load** icon.  Load..

The **Load LineStyles** dialog box is displayed

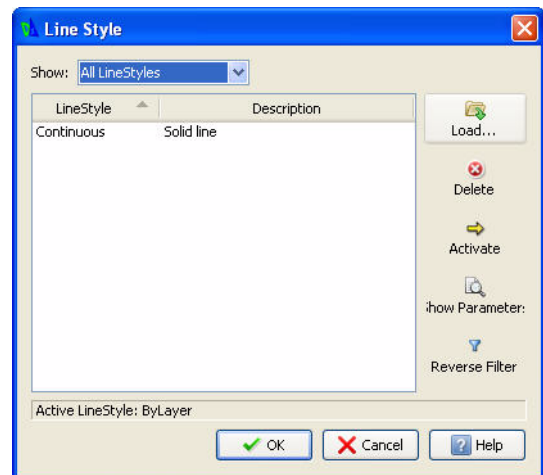
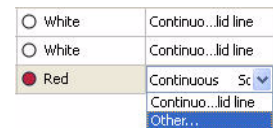

**Note:** The default LineStyle file: inch.lin.  
Click the **Browse** button.

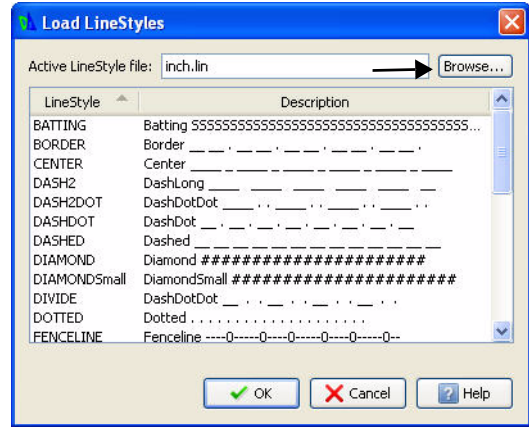

Select **MM.LIN** from the **Specify LineStyle File** dialog box.

Click Open from the **Specify LineStyles File** dialog box.



Select **HIDDEN** from the **Load LineStyles** dialog box.

Click **OK**.

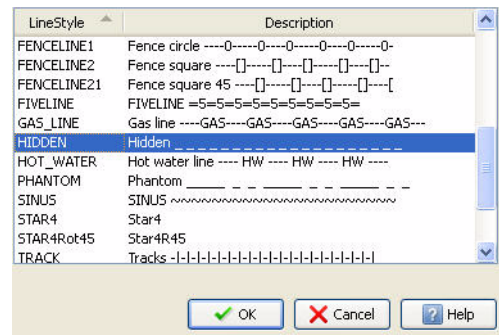

**NOTE:** Use the scroll bar on the right to view items in the dialog box.



HIDDEN is added to the **LineStyle** dialog box.

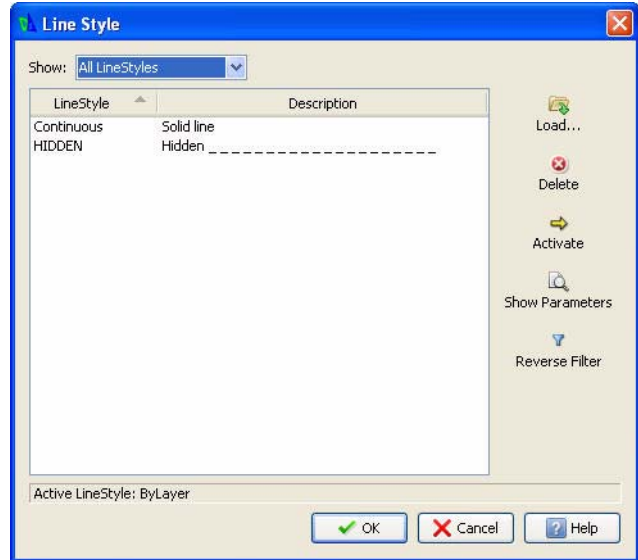

**7 Create the Second Layer LineStyle.**  
 Create a MM CENTER LineStyle.

Click the **Load** icon.

View the **Load LineStyles** dialog box.  
 The default LineStyle file: inch.lin.

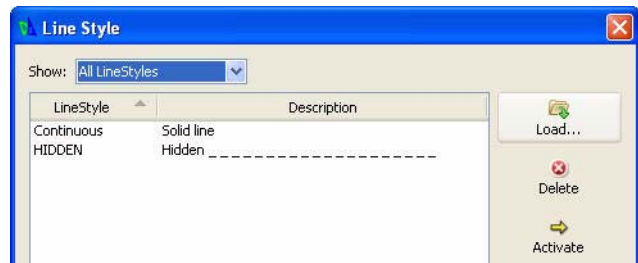

Click the **Browse** button.

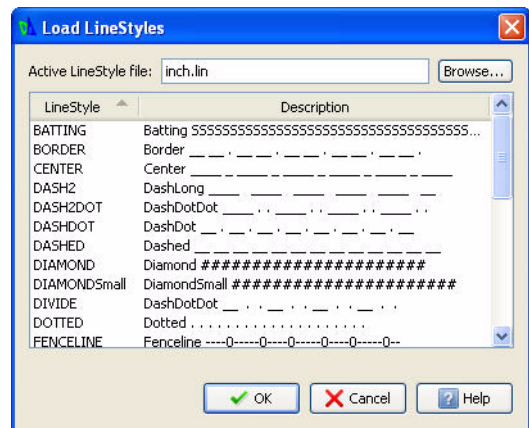

Select **MM.LIN** from the **Specify LineStyle File** dialog box.

Click Open from the Specify LineStyles File dialog box

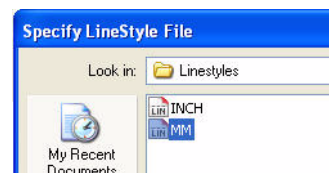

Click **CENTER** from the **Load LineStyles** dialog box.  
Click **OK**.

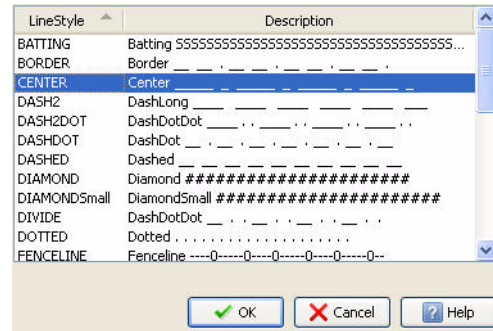

**CENTER** is added to the **Line Styles** dialog box.  
Click **OK**.

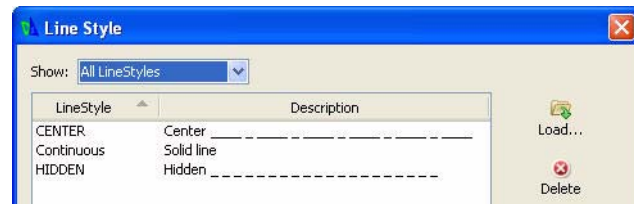

**8 Click OK from the Line Style Dialog Box.**

**9 View the Available New LineStyles**  
Double-click inside the **LineStyle** cell.

View the **HIDDEN** and **CENTER LineStyle** from the drop-down menu.

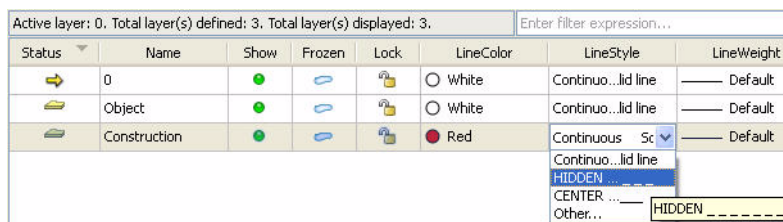

**10 Set HIDDEN for LineStyle.**

Click **HIDDEN** in the **LineStyle** cell for the Construction Layer.  
*HIDDEN* is the new the **LineStyle** for the Construction Layer.  
Click **OK**.

**11 Save the Drawing.**

Click the **Save** icon  on the Standard toolbar.

**Enter** File name: Lesson 2-1.

Click **Save**.

**12 Create the third new Layer.**

Click the **Layers Manager** icon  on the Layer toolbar.

The **Layers Manager** dialog box is displayed.

Click the **New Layer**  icon. The new default name is Layer 1.

Rename this Layer **Centerline**.

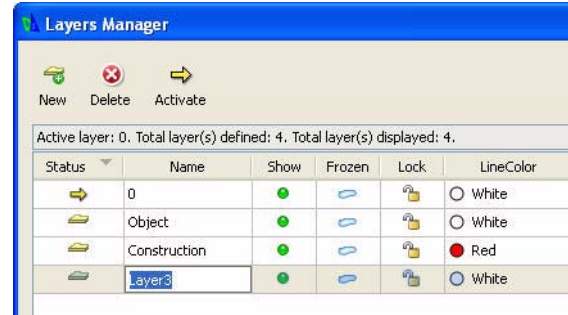

*Centerline* is the new Layer name.

Press the **Enter** key.

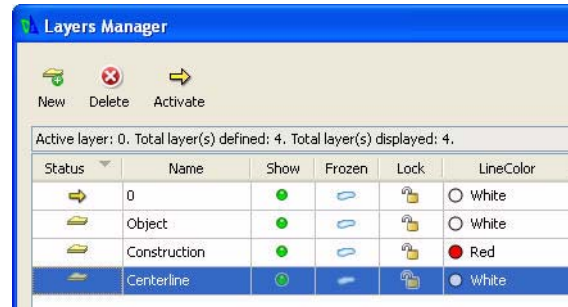

### 13 Set the Third Layer LineColor.

New Layers are automatically assigned the LineColor white.

Double-click the **LineColor** cell for the **Centerline** Layer.

Click **Blue**.

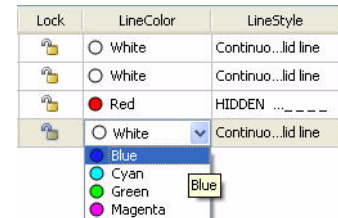

### 14 Set the Third Layer LineStyle.

Double-click the **LineStyle** cell for the Centerline Layer.

Click **CENTER**.

*CENTER* is new the **LineStyle** for the Centerline Layer.

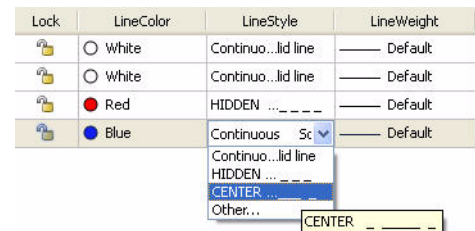

### 15 Add a Description.

Double-click inside the **Description** cell for the Centerline Layer.

Enter **Customer XYZ**.

Press the **Enter** key.

PrintStyle	Print	Description
Color_7	🖨️	
Color_7	🖨️	
Color_1	🖨️	
Color_5	🖨️	Customer XYZ

**NOTE:** At this time, the default Layer is active.

**16 Activate the Object Layer.**

Double-click the icon in the **Status** box next to the Object Layer. A

➡ is displayed in the **Status** box.

*Object* is now the current Layer.

Click **OK**.

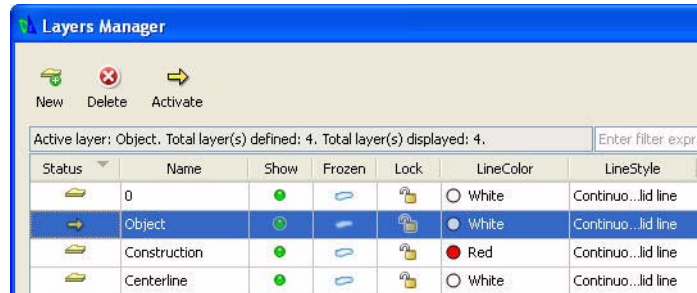

View the status of the Layers toolbar and the Properties Palette.

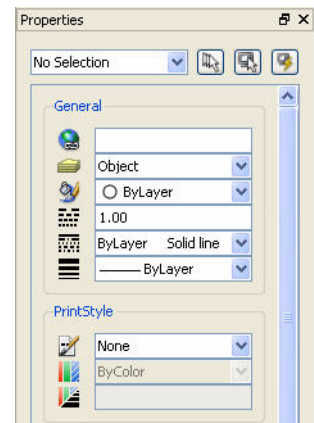
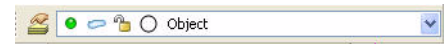

## Create the First New Drawing

### Draw a Circle

In this section, use the **Circle, Center, Radius** command from the drop-down menu. Click the graphics area to define the center point of the Circle or enter an absolute coordinate position at the Command prompt. Click the drawing to define the Circle radius, or enter the radius value at the Command prompt.

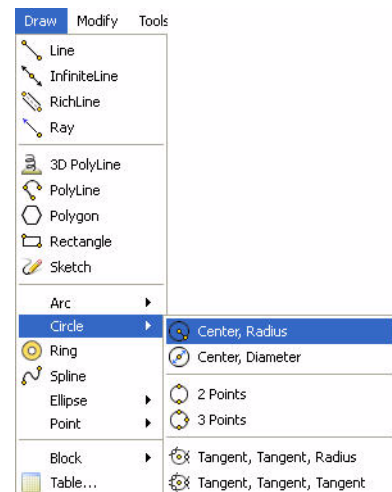

**NOTE:** You can also use the **Circle** icon on the Draw toolbar.

**1 Draw a 20mm Radius Circle as the First Entity.**

Click **Draw, Circle, Center, Radius** from the Main Menu.

Options: 3Point, 2Point, Itr, III Enter to exit or

Specify center point»140,150 ↵

Option: Diameter or

Specify radius»20↵

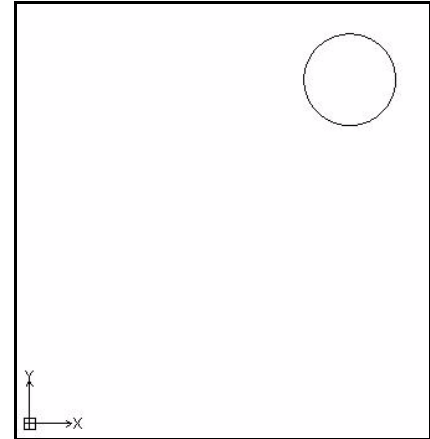
**Draw a Hexagon**

Draw a hexagon using the **Polygon** command. A Polygon is a closed linear PolyLine segment consisting of between 3 and 1024 equal length sides.

**1 Draw a six Side Hexagon.**

Click **Draw, Polygon** from the Main Menu.

Default: 4

Enter number of Sides» 6 ↵

Options: Side Length or

Specify center point»

Click the center point of the Circle in the graphics area.

Default: COrner

Options: Corner, or Side

Specify distance option»s ↵

Specify distance» 10 ↵

**2 Save the Drawing.**

Click the **Save** icon  on the Standard toolbar.

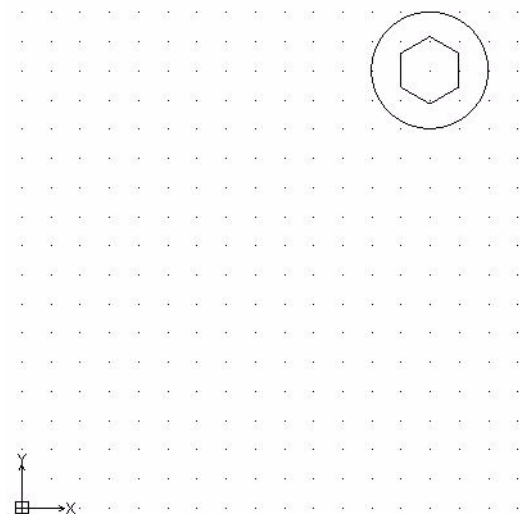
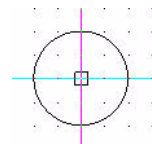
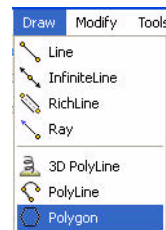

Copy Command

Use the **Copy**  command to duplicate drawing entities by selecting drawing entities and placing a copy of them at a specified position. The duplicated entities are exact copies of the selected entities including all entity properties such as Layers, LineStyles, LineColors, and LineWeight.

**1 Copy the Existing Circle to the Right of the Drawing.**

**2 Turn Snap Off.**

Click the **Snap**  button on the Status bar. The command window displays: <Snap Off>.

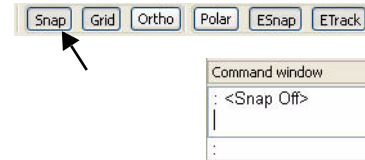

**NOTE:** With Snap On, the cursor can only select points positioned directly on the snap grid.

**3 Click the Copy Icon  on the Modify Toolbar.**

Specify entities»

Click the circumference of the Circle. The Circle is highlighted by turning dotted.

1 found, 1 total

Specify entities»

Default: Displacement

Options: Displacement or

Specify from point»

Click the center point of the Circle in the graphics area.

Options: Enter to use first point as displacement or

Specify second point» 220,150

Default: Exit

Options: Exit, Undo or

Specify second point: »

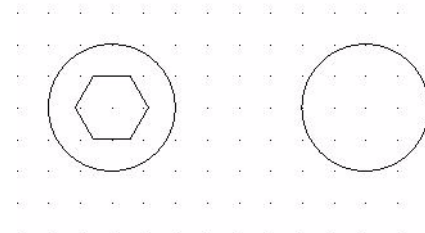
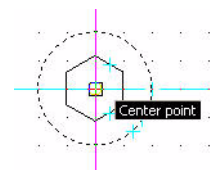
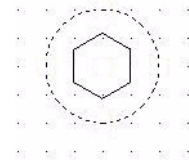

### Modify the Diameter of the Copied Circle

Use the Properties Palette to modify the diameter of the copied Circle. The Properties Palette allows you to view and change drawing entity properties. The Properties Palette is located on the right side of the graphics area.

#### 4 Modify the Circle Diameter.

Click the circumference of the copied Circle.

Delete **20.00** for Radius in the Properties Palette.

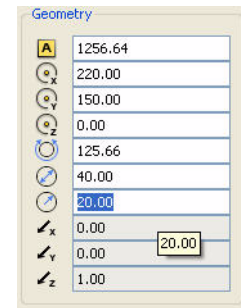
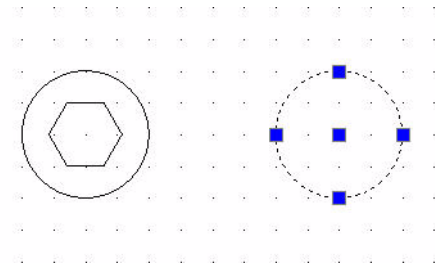

Enter **10**.

Press **Esc** or **Enter** to exit.

#### 5 Save the Drawing.

Click the **Save** icon  on the Standard toolbar.

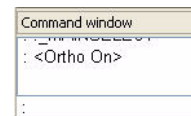
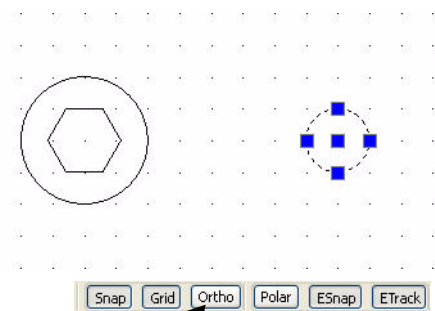

### Draw Two Parallel and Horizontal Lines

Turn **Ortho** mode on.

Click the **Ortho**  button on the Status bar.

The command window displays:

<Ortho On>.

Orthogonal mode limits the cursor movement so that it moves parallel to the axes of the coordinate system. You can only enter points located parallel to these axes. Orthogonal mode makes it easier to draw and place parallel or colinear Lines on entities.

#### 6 Draw the First Linear Segment.

Click the **Line** icon  on the Draw toolbar.

Options: Segments or

Speci fy start poi nt»

Click the top quadrant point of the small Circle.

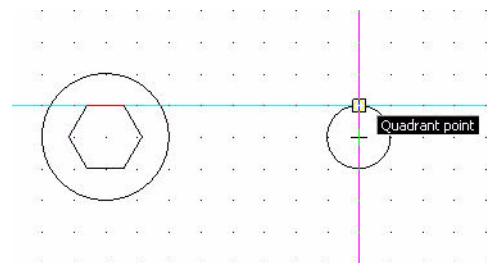



Options: Segments, Undo *Enter to exit* or  
Speci fy next poi nt»

Draw a Line from the top quadrant point to a point within the large Circle as illustrated.

Click a point.

Options: Segments, Undo *Enter to exit* or  
Speci fy next poi nt»↵

:

### 7 Draw the Second Linear Segment.

Click the **Line** icon  on the Draw toolbar.

Options: Segments or  
Speci fy start poi nt»

Click the bottom quadrant point of the small Circle.

Options: Segments, Undo *Enter to exit* or  
Speci fy next poi nt»

Draw a Line from the bottom quadrant point to a point within the large Circle as illustrated.

Click a point.

Options: Segments, Undo *Enter to exit* or  
Speci fy next poi nt»↵

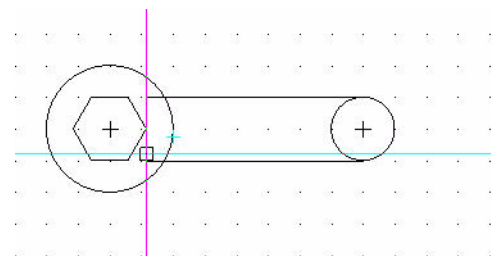
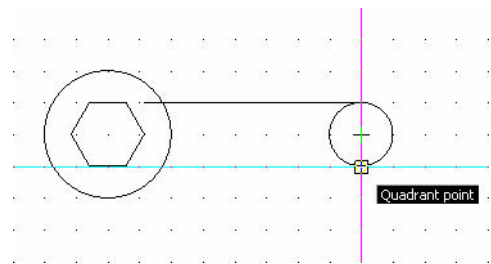
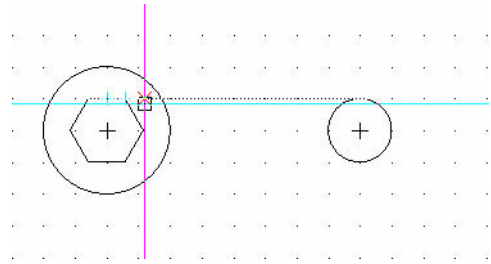

## Trim Command

The **Trim**  command provides the ability to cut drawing entities precisely at the edges defined by one or more entities.

**Lines, InfiniteLines, Rays, PolyLines, Circles, Arcs, or Ellipses** can act as cutting edges and as a result of the command execution be trimmed. **Blocks** and **text** cannot be trimmed or used as cutting edges. In a sheet the entities of type ViewPort can also be cutting edges. When you select a PolyLine as cutting edge, the command trims at its centerline.



## 8 Trim the Top and Bottom Horizontal Lines Back to the Large Circle.

Click the **Trim** icon  on the Modify toolbar.

Specify cutting edges...

Options: *Enter to specify all entities or Specify entities»*

Click the circumference of the large Circle.

1 found, 1 total

Options: *Enter to specify all entities or Specify entities»*

Options: Crossing, Crossline, Project, Edge, eRase, *Shift + select to extend or*

Specify segments to remove»

Click the bottom Horizontal Line inside the large Circle.  
The inside bottom Line is trimmed.

Options: Crossing, Crossline, Project, Edge, eRase, *Shift + select to extend or*

Specify segments to remove»

Click the top Horizontal Line inside the large Circle.  
The inside top Line is trimmed

Options: Crossing, Crossline, Project, Edge, eRase, *Shift + select to extend or*

Specify segments to remove»

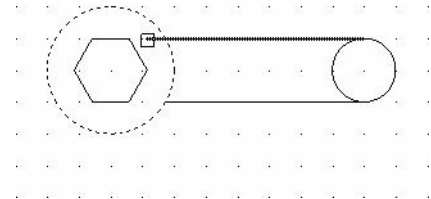
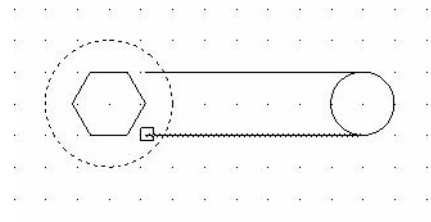
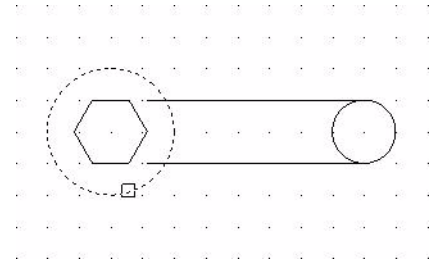

## 9 Turn Ortho Mode Off.

Click the **Ortho**  button on the Status bar.

### Fillet Command

The **Fillet**  Command allows you to create rounded corners by replacing part of two Lines with an Arc. The filleted entities do not have to intersect, and they can overlap. If the entities overlap, they will be trimmed (by default) to create the rounded corner. In any case, the Lines to be filleted are connected to the fillet arc.

Applying a fillet radius of 0 will result in creating sharp corners instead of rounded. You can hold down the Shift key on the keyboard while selecting the entities to override the current fillet radius with a value of 0.

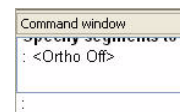

In the next section, draw two fillets between the Horizontal Lines and the large Circle.

### 10 Create the First Fillet.

Click the **Fillet** icon  on the Modify toolbar.

Mode = TRIM, Radius = 0.00.

Set the Radius to 5mms.

Options: Mul ti pl e, Pol yl i ne, Radi us, Tri m mode, Undo or  
Speci fy fi rst enti ty»r ↵

Defaul t: 0. 00

Speci fy radi us» 5. ↵

Options: Mul ti pl e, Pol yl i ne, Radi us, Tri m mode, Undo or  
Speci fy fi rst enti ty»

Click the bottom Horizontal Line.

Options: Shi ft + select to apply corner or  
Speci fy second enti ty»

Click circumference of the large Circle below the  
bottom Horizontal Line.

View the fillet in the graphics area.

### 11 Create the Second Fillet Entity.

Click the **Fillet** icon  on the Modify toolbar.

Mode = TRIM, Radius = 5.00

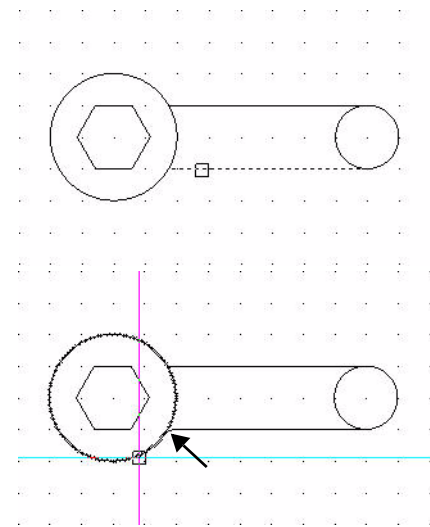

**NOTE:** Pressing **Enter** on the keyboard will recycle the previous command.

Options: Mul ti pl e, Pol yl i ne, Radi us, Tri m mode, Undo or  
Speci fy fi rst enti ty»

Click the top Horizontal Line.

Options: Multiple, Polyline, Radius, Trim mode, Undo or  
Specify first entity»

Click circumference of the large Circle above the top Horizontal Line.

View the fillet in the graphics area.

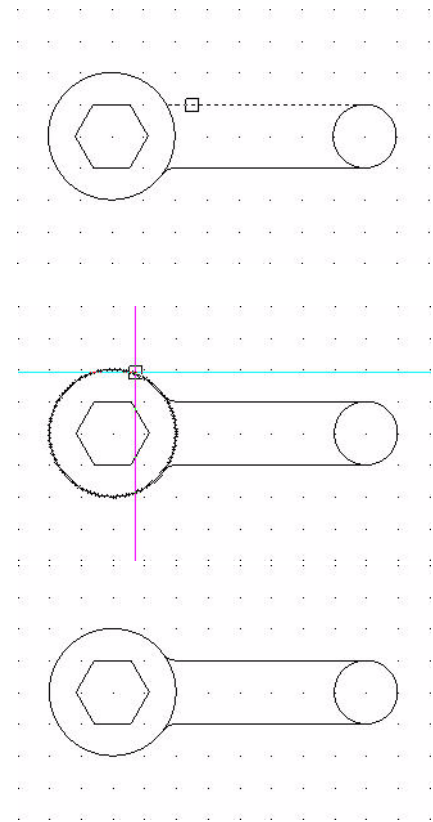

#### NOTE:

Since we set the fillet radius to 5 earlier, it is not necessary to enter a new radius unless the value were to change.

### Mirror Command

The **Mirror**  command allows you to copy selected entities onto the opposite side of a specified Mirror Line. To define the mirror axis, specify two points.

#### NOTE:

By default, the **Mirror** command retains text direction when entities are mirrored.

#### 12 Apply the Mirror Command.

Click the **Mirror** icon  on the Modify toolbar.

Specify entities»

Window select all entities in the graphics area.

Click a position to the top left of the drawing.

Click a position below the bottom right of the drawing. The selected entities inside the graphics area are displayed.

7 found, 7 total

Specify entities»

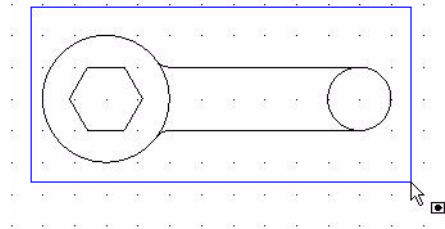

Specify start point of mirror line»

Click the top quadrant point of the large Circle as illustrated.

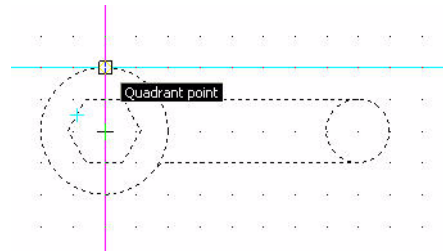

Specify end point of mirror line»

Click the bottom quadrant point of the large Circle. Accept the default setting.

Default: No

Confirm: Delete source entities?

Specify Yes, or No»

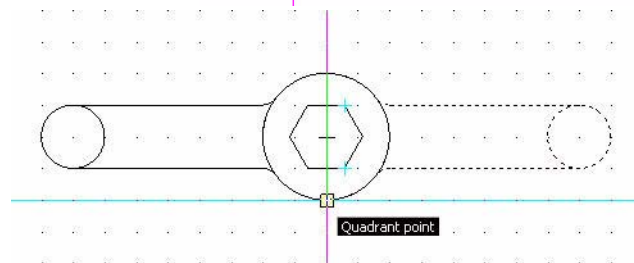

### 13 Save the Drawing.

Click the **Save** icon  on the Standard toolbar.

### Rotate Command

Use the **Rotate**  command to rotate entities through an angle, about a base point. By default, rotation is counterclockwise.

#### NOTE:

When you rotate, set the Orthogonal mode to constrain the angle of rotation to 90 degree intervals.

### 14 Rotate the Geometry 30 Degrees

Click the **Rotate** icon  on the Modify toolbar.

Active positive angle in CCS: DIRECTION+counterclockwise BASE=0

Specify entities»

Window-select all entities in the graphics area.

Click a position to the top left of the geometry.

Drag downward and to the right as illustrated.

Click a position below the bottom right of the geometry.

The selected entities inside the graphics area are displayed.

14 found, 14 total

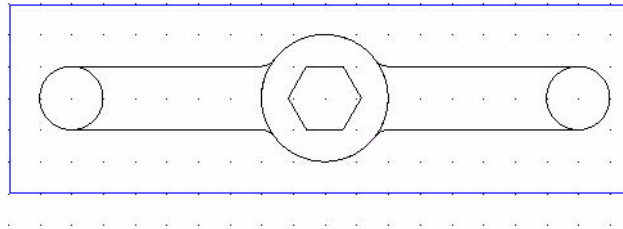

Specify entities»↵

Specify pivot point»

Click the center point of the large Circle.

Default: 0

Options: Reference or

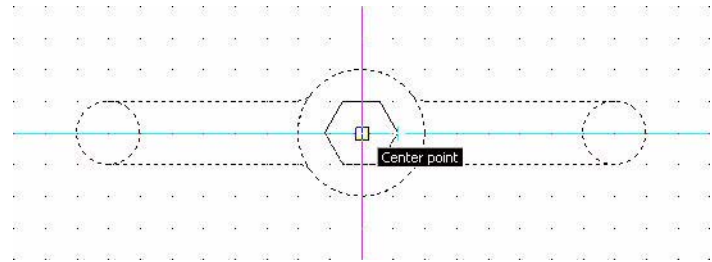

Specify rotation angle»30 ↵

### 15 Save the Drawing.

Click the **Save** icon  on the Standard toolbar.

### Trim Command

The **Trim**  command cuts drawing entities precisely at the edges defined by one or more entities. Use the Trim tool to remove the inside (small) Circle entity.

### 16 Trim the First Circle Entity.

Click the **Trim** icon  on the Modify toolbar.

Specify cutting edges...

Options: *Enter to specify all entities* or

Specify entities»

Click the bottom Line on the left side and the top Line on the left side.

1 found, 2 total

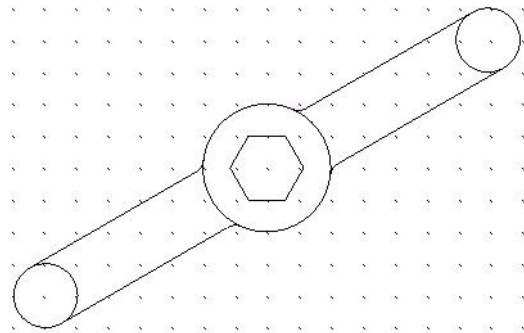

Options: *Enter to specify all entities or Specify entities»*↓

Options: Crossing, Crossline, Project, Edge, eRase, Undo, *Shift + select to extend or*

Specify entity to remove»↓

Click right side of the circumference of the small Circle that is on the left side of the entity as shown.

Specify entity to remove»↓

### 17 Trim the Second Circle Entity.

Click the **Trim** icon  on the Modify toolbar.

Specify cutting edges...

Options: *Enter to specify all entities or Specify entities»*

Click the bottom Line on the right side and the top Line on the right side.

1 found, 2 total

Options: *Enter to specify all entities or*

Specify entities»↓

Click left side of the circumference of the small Circle that is on the right side of the entity as shown

Options: Crossing, Crossline, Project, Edge, eRase, Undo, *Shift + select to extend or*

Specify entity to remove»↓

### 18 Save the Drawing.

Click the **Save** icon  on the Standard toolbar.

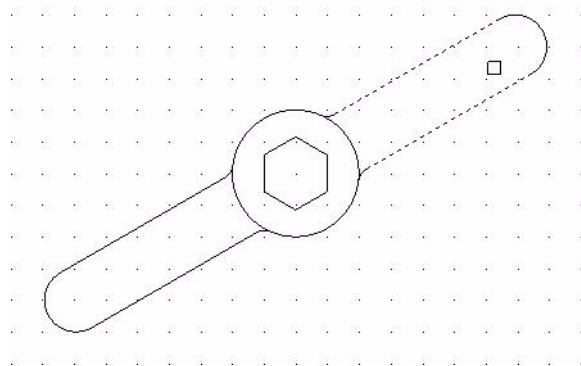
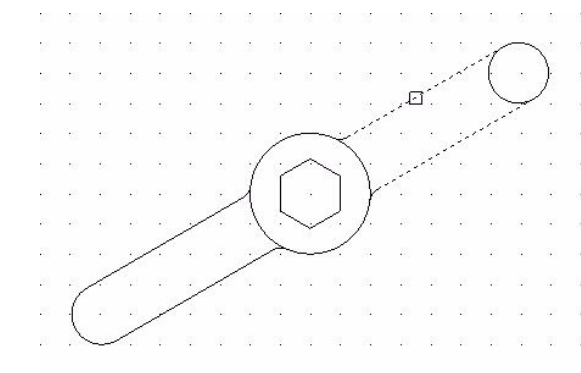
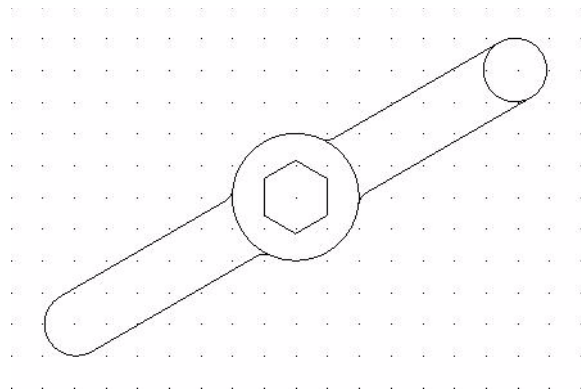

## Draw Entities on the Centerline Layer

In this next section, draw a **Line**, **Circle**, and **Rectangle** on the Centerline Layer. Only display the Centerline Layer.

### 19 Open the Layers Manager Dialog Box.

Click the **Layers Manager** icon . The **Layers Manager** dialog box is displayed. At this time, all Layers are displayed: Default (0), Object, Construction, and Centerline.

Activate the Centerline Layer

Double-click the **Status** icon  in the Centerline Layer **Show** cell.

Turn the Default Layer (0) Off.

Double-click the **Show** icon  in the default (0) **Show** cell.

Turn the Construction Layer Off.

Double-click the **Show** icon  in the Construction **Show** cell.

Turn the Object Layer Off

Double-click the **Show** icon  in the Object **Show** cell.

Click **OK** from the Layer Manager dialog box.

View an empty work space.

### 20 Save the Drawing.

Click the **Save** icon  on the Standard toolbar.

### 21 Draw a Linear Segment.

Click the **Line** icon  on the Draw toolbar.

Options: Segments or

Specify start point»50,50 ↵

Options: Segments, Undo, *Enter to exit* or

Specify next point»160,50 ↵

Options: Segments, Undo, *Enter to exit* or

Specify next point» ↵

The blue **LineStyle CENTER** is displayed on the Centerline Layer.

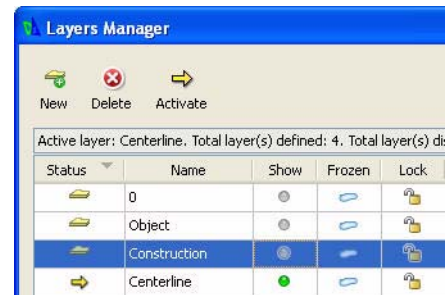
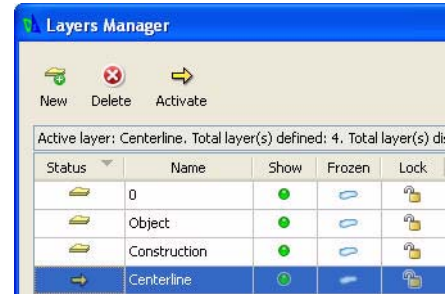

**22 Draw a Circle Entity.**

Click the **Circle** icon  on the Draw toolbar.

Options: 3Point, 2Point, Itr, ITT, *Enter to exit* or

Specify center point»**100,130**↵

Options: Diameter or

Specify radius»**d**↵

Specify diameter»**45.5**↵

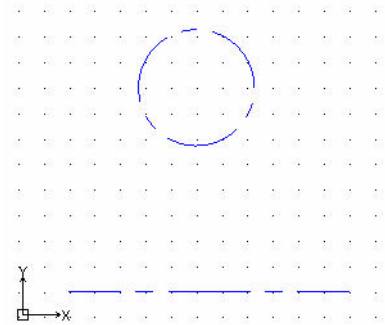

The blue **LineStyle CENTER** is displayed on the Centerline Layer.

**Rectangle Command**

The **Rectangle**  command creates a closed PolyLine in a rectangular shape. A PolyLine is a drawing entity that consists of connected Lines or connected Arc segments. You can specify the **area**, **dimensions** or **rotation** parameters. You can also control the type of corners on the rectangle.

**23 Draw a Rectangle Entity.**

Click the **Rectangle** icon  on the Draw toolbar.

Options: Chamfer, Elevation, Fillet, Thickness, Line Width or

Specify start corner»**180,120**↵

Options: Area, Dimensi ons, Rotati on or

Specify opposi te corner»**240,50**↵

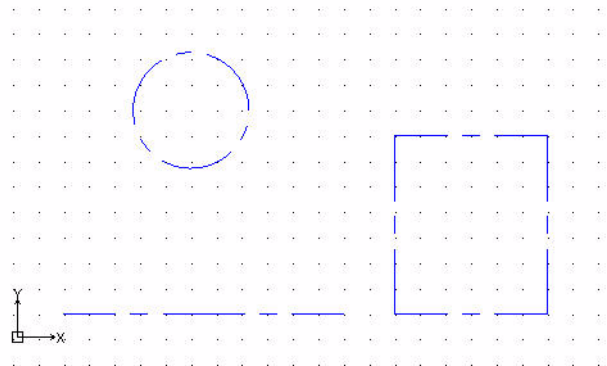
**24 Save the Drawing.**

Click the **Save** icon  on the Standard toolbar.

**SimpleNote Command**

The SimpleNote  command creates a single line text entity of any position, orientation, justification, and style. When you issue the command, you are prompted with a dialog box that will enable these options.

**25 Apply the SimpleNote Command.**

The SimpleNote command displays text in the graphics area as it is entered.

Click the **SimpleNote** icon  on the Draw toolbar.



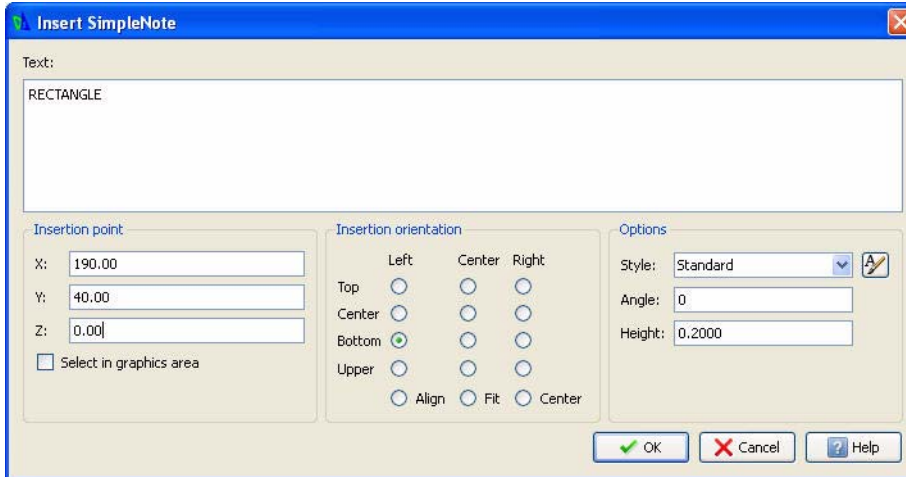

## 26 Complete the Insert SimpleNote Dialog.

Input the word **RECTANGLE** in the **text:** field.

Use **Insertion point**

X: **190**

Y: **40**

Change **Height:** to **5**.

Click **OK**.

## 27 Save the Drawing.

Click the **Save** icon  on the Standard toolbar.

## Draw a Spline on the Construction Layer

In this next section, you will draw a **Spline** on the Construction Layer. The default Layer, Object Layer and Construction Layer are not shown at this time.

## 28 Turn the Centerline Layer Off.

Click the drop-down arrow from the **Layers Manager**.

Click the **Show** icon in the *Centerline* row.

Click **OK** from the pop-up dialog box.

Make the Construction Layer active.

Click the drop-down arrow from the **Layers Properties Manager**.

Click **Construction**.

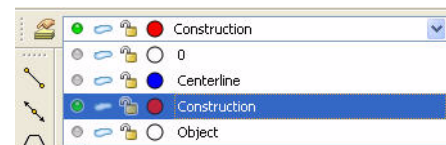
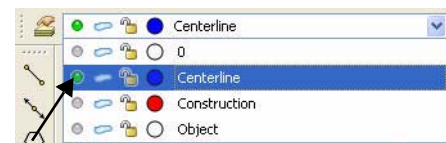

**NOTE:** The Construction Layer is displayed in the graphics area.  
The Default Layer, Object Layer and the Centerline Layer are Off.

## 29 Save the Drawing.

Click the **Save** icon  on the Standard toolbar

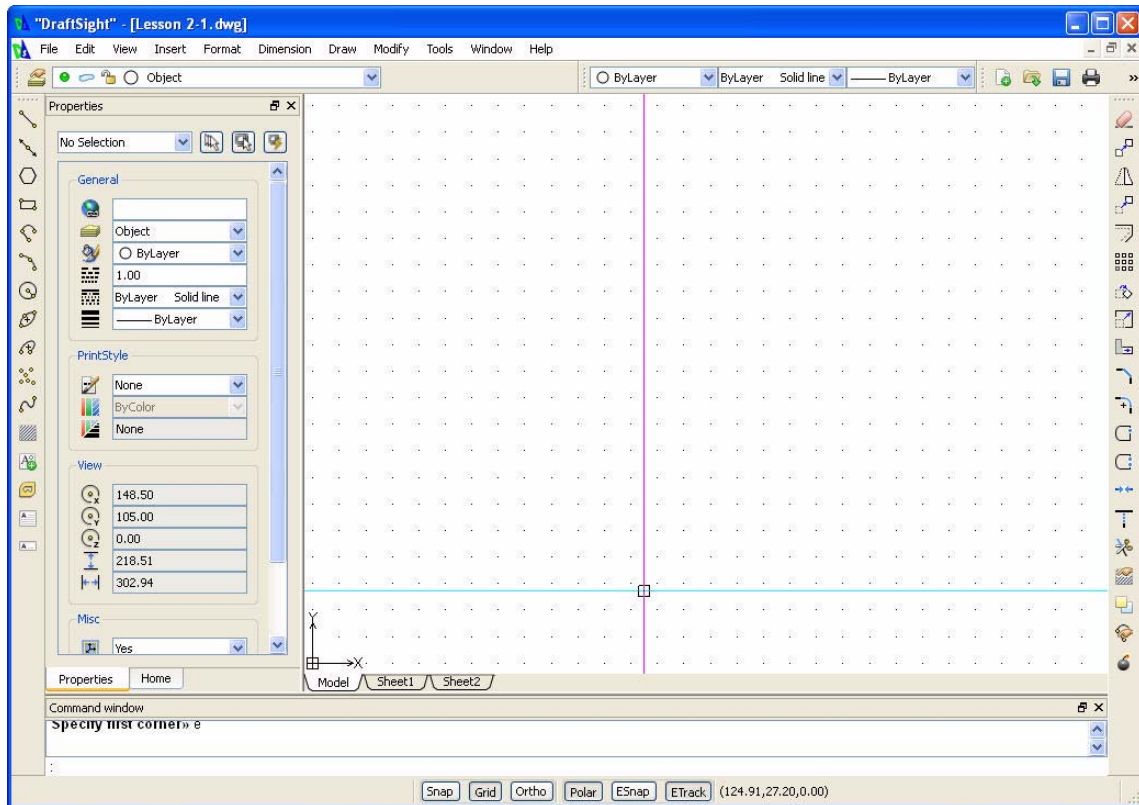

## Spline Command

The **Spline**  command provides the ability to draw a smooth curve that is fit to a set of points. You can create a non-uniform rational B-Spline or NURBS curve for any number of fit points. You can also fit the Spline to the specified points to within a specified tolerance value.

## 30 Draw a Spline Entity.

Click the **Spline** icon  on the Draw toolbar.

Specify start fit point»150,60↵

Specify next fit point»185,80↵

You can either click the graphics area or enter successive points to continue the Spline or enter **F** to define a fit tolerance and then click or enter other Spline points. In the next section, enter a fit tolerance of **.2mm**.

Options: Close, Eit tolerance, *Enter for start tangent* or  
 Specify next fit point»f.↓

Default: 0.00

Specify fit tolerance»2.↓

Options: Close, Eit tolerance, *Enter for start tangent* or  
 Specify next fit point»100,40 ↓

Options: Close, Eit tolerance, *Enter for start tangent* or  
 Specify next fit point»115,25.5 ↓

Options: Close, Eit tolerance, *Enter for start tangent* or  
 Specify next fit point»c ↓

Specify tangency»

Click a position inside the graphics area as illustrated. Your drawing may differ depending on the position that you select in the graphics area.

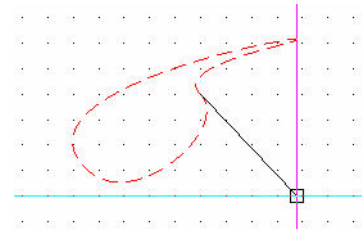

### 31 Delete the Spline Entity.

Select the Spline entity.

Click the **Delete** icon .

### 32 Save the Drawing.

Click the **Save** icon  on the Standard toolbar.

#### NOTE:

The fit tolerance applies to all fit points until you change it. Setting the fit tolerance to zero forces the Spline to pass through the fit points.

## PolyLine Command

The **PolyLine**  command creates an equilateral (edges with equal length) closed PolyLine. A PolyLine is a drawing entity that consists of connected Lines or connected Arc segments. The number of sides can vary from 3 (which forms an equilateral triangle) to 1024.

You can create PolyLines with segments of different widths and fill settings. The default segment type for a PolyLine is a Linear Segment.

### 33 Draw a PolyLine Segment on the Construction Layer

Click the **PolyLine** icon  on the Draw toolbar.

Options: *Enter to continue from last point or*

Specify start point»**50,50**␣

Options: Arc, Hal fwi dth, Length, Undo, Width, *Enter to exit or*

Specify next vertex»**100,50**␣

Options: Arc, Hal fwi dth, Length, Undo, Width, *Enter to exit or*

Specify next vertex»**130,25**␣

Options: Arc, Hal fwi dth, Length, Undo, Width, *Enter to exit or*

Specify next vertex»**180,25**␣

Options: Arc, Hal fwi dth, Length, Undo, Width, *Enter to exit or*

Specify next vertex»**200,50**␣

Options: Arc, Hal fwi dth, Length, Undo, Width, *Enter to exit or*

Specify next vertex»**250,50**␣

Options: Arc, Hal fwi dth, Length, Undo, Width, *Enter to exit or*

Specify next vertex»**250,100**␣

Options: Arc, Hal fwi dth, Length, Undo, Width, *Enter to exit or*

Specify next vertex»**230,130**␣

Options: Arc, Hal fwi dth, Length, Undo, Width, *Enter to exit or*

Specify next vertex»**200,130**␣

Options: Arc, Hal fwi dth, Length, Undo, Width, *Enter to exit* or  
Speci fy next vertex»**180,100**↵

Options: Arc, Hal fwi dth, Length, Undo, Width, *Enter to exit* or  
Speci fy next vertex»**130,100**↵

Options: Arc, Hal fwi dth, Length, Undo, Width, *Enter to exit* or  
Speci fy next vertex»**100,130**↵

Options: Arc, Hal fwi dth, Length, Undo, Width, *Enter to exit* or  
Speci fy next vertex»**75,130**↵

Options: Arc, Hal fwi dth, Length, Undo, Width, *Enter to exit* or  
Speci fy next vertex»**50,100**↵

Options: Arc, Hal fwi dth, Length, Undo, Width, *Enter to exit* or  
Speci fy next vertex↵

### 34 Save the Drawing.

Click the **Save** icon  on the Standard toolbar.

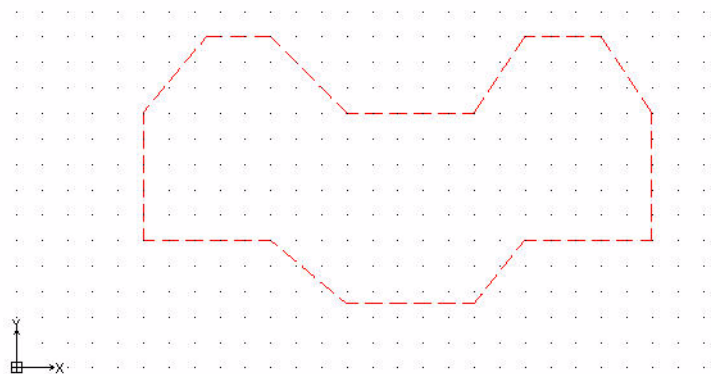

Click any segment of the entity in the graphics area. View the EGrips. The EGrips display a single entity. Remember, EGrips are selectable handles (displayed as small squares) at the end points, center, vertices, insertion points, and other geometric points of entities.

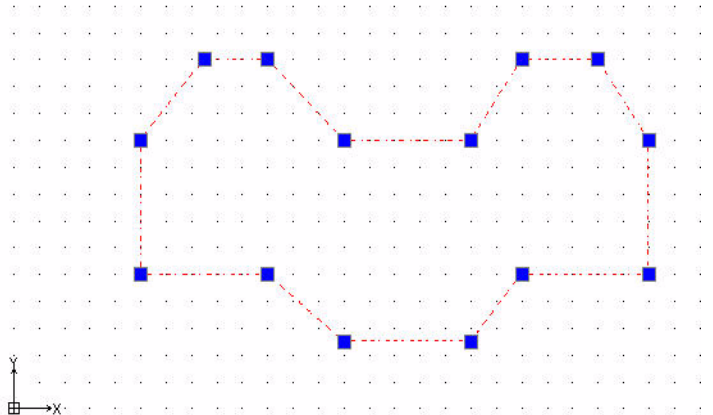

### 35 Remove the EGrips.

Press **Esc** or **Enter** to exit.

## Edit PolyLine Command

The **Edit PolyLine**  command provides the ability to edit PolyLines, PolyLine vertices, and three-dimensional polygon meshes in several ways. PolyLines can be modified in the following ways:

- Open a close PolyLine or close an open PolyLine
- Join a PolyLine with other drawing entities such as Line, Arc or PolyLine
- Modify the width of the whole PolyLine
- Edit individual PolyLine segments by editing their control points (vertices)

### Modify the PolyLine Width

In the following section, modify the width of the PolyLine from .2mm to 5mm.

#### 36 Apply the Edit PolyLine Command.

Click the **Edit PolyLine** icon  on the Modify toolbar.

Options: Multiple or  
Speci fy pol yLi ne»

Click a **Line segment** of the polyline.

Options: Decurve, Edit vertex, Eit, Join, Lengthen, Open, Spline, Undo, Width, or eXit

Speci fy opti on»w ↵

Speci fy new wi dth»5 ↵

Options: Decurve, Edit vertex, Eit, Join, Lengthen, Open, Spline, Undo, Width, or eXit

Speci fy opti on»x ↵

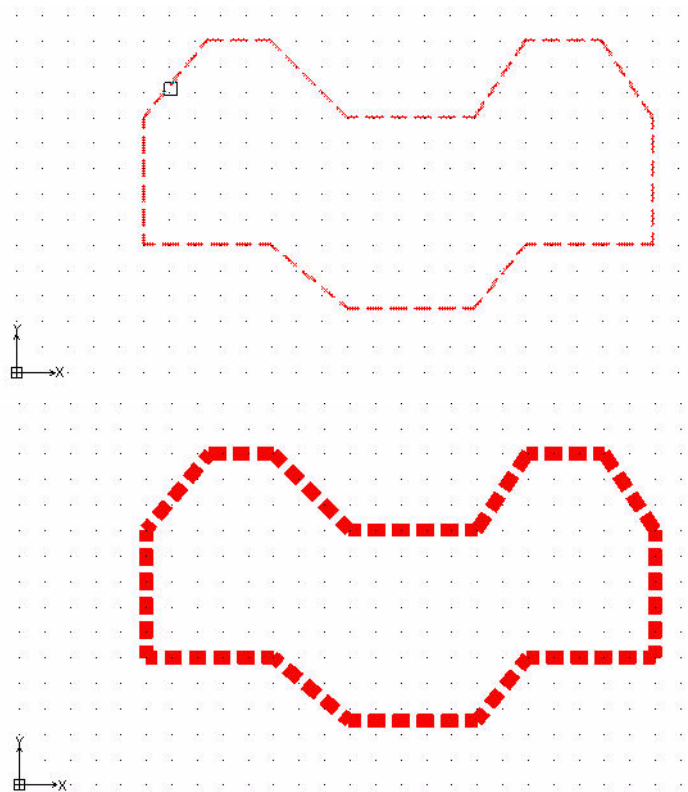

#### 37 Undo the Modification.

Click the **Undo** icon  on the Standard toolbar.

#### 38 Turn the Construction Layer Off.

Click the drop-down arrow from the **Layers Properties Manager**.

Click the **Show** icon  in the **Construction** row.

Click **OK** from the pop-up dialog box.

A gray **Show** icon  is displayed.

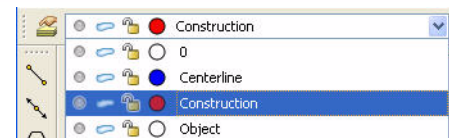

### Return and Activate the Object Layer.

Return to the Object Layer.

#### 39 Show the Object Layer.

Click the drop-down arrow from the Layers Properties Manager.

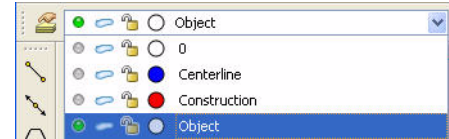

Click the **Show** icon  in the Object Layer row. A green **Show** icon  is displayed.

#### 40 Activate the Object Layer.

Click **Object**. The Object Layer is active.

#### 41 Save the Drawing.

Click the **Save** icon  on the Standard toolbar.

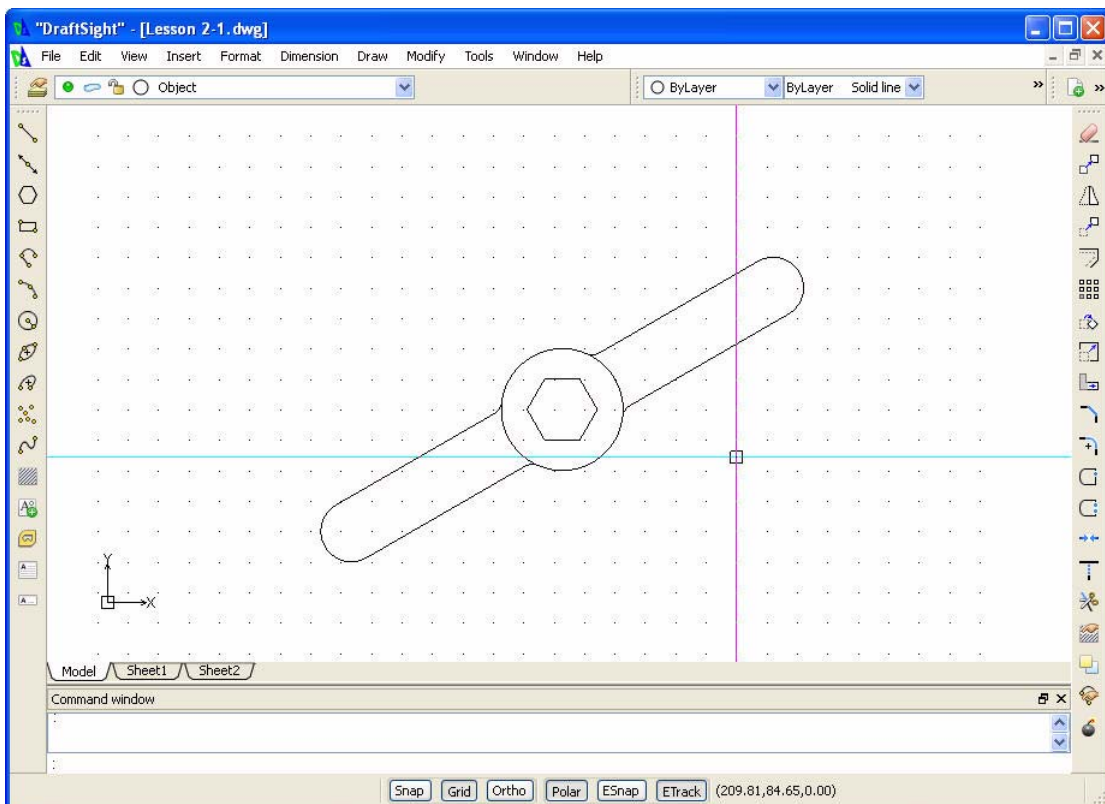



## Create a Second New Drawing

Create three new Layers. Use the **Rectangle**, and **Circle** commands.

Apply the **Pattern** command to create a Circular and Linear pattern along with the **Chamfer** command.

Create an Object Layer and a Centerline Layer. Set custom Layer properties.

### 1 Create a New Drawing.

Click the **New** icon  on the Standard toolbar.

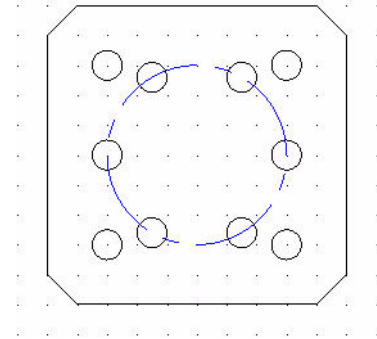

## Drawing Template

### 2 Select a Default Drawing Template.

Double-click `standard.dwt` from the **Select Template** dialog box.

## Set the Drawing Environment

### Drawing Unit System

The default units system is the Decimal system and can be applied to either English (inches) or metric values (millimeters).

### 3 Set Linear Length Precision.

The **Unit System** section of the **Options - Drawing Settings** dialog box allows you to set the linear and angular unit formats.

Click **Format, Unit System...** from the Main Menu.

The **Unit System** portion of the **Options - Drawing Settings** dialog box is displayed.

Click **0.00** for **Precision** in the **Length** section of the dialog box.



### 4 Set Linear Units Scale.

The **Units scale** section of the **Unit System** dialog box allows you to set the linear and angular unit formats.

Click **Millimeters** for **Block units format** in the **Units scale** section of the dialog box.

Click **OK**.

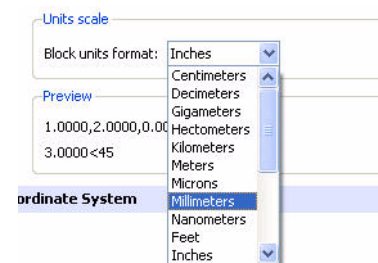



### Set Drawing Boundary

Use a horizontal A4 default drawing sheet.

#### 5 Set Drawing Boundary.

Click **Format, Drawing Boundary** from the Main Menu.

Default t: (0.00, 0.00)

Options: **Off**, **On** or

Specify lower left corner» ↵

Default t: (12.00, 9.00)

Specify upper right corner» **297,210**↵

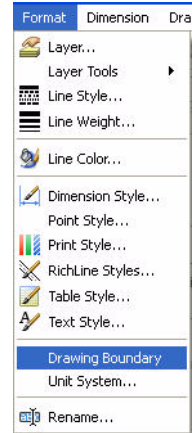

### Set Snap and Grid

Set the **Snap** and **Grid**. In this section the Grid equals the Snap.

#### 6 Set Snap and Grid.

Click **Tools, Options** from the Main Menu.

The **Options** dialog box is displayed.

Click the **User Preferences** tab.

Expand **Drafting Options, Pointer Control** and **Snap Settings**.

Click the **Enable Snap <F9>** box.

Enter the value of **10** in the **Horizontal Snap spacing** box. Press the **Tab** key The **Vertical Snap spacing** box is updated.

Expand **Display** and **Grid Settings**

Click the **Enable Grid <F7>** box and the **Match Snap Spacing** box. The **Horizontal display spacing** value and the **Vertical display spacing** value will be set to **10.00**.

Click **OK**.

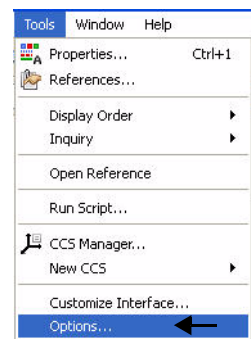

### Zoom Bounds

#### 7 Display the Drawing with the New Boundary.

Drawing boundaries need to be used to adjusted to the current view.

#### 8 Select **View, Zoom, Bounds** from the Main Menu.

#### 9 Save the Drawing.

Click the **Save** icon  on the Standard toolbar.

Enter **File name:** Lesson 2-2.

Click **Save**.

### Create New Layers for the Drawing

In this section, you will create three new Layers called Object, Construction and Centerline. As well as apply custom properties.

#### 10 Create the First New Layer.

Click the **Layers Manager** icon  on the Layers toolbar

The **Layers Manager** dialog box is displayed.

**NOTE:** You can also click **Format, Layer** from the Main Menu to display the Layer Manager dialog box.

Click the **New Layer** icon.  The new default name is Layer 1.

Rename this Layer **Object**

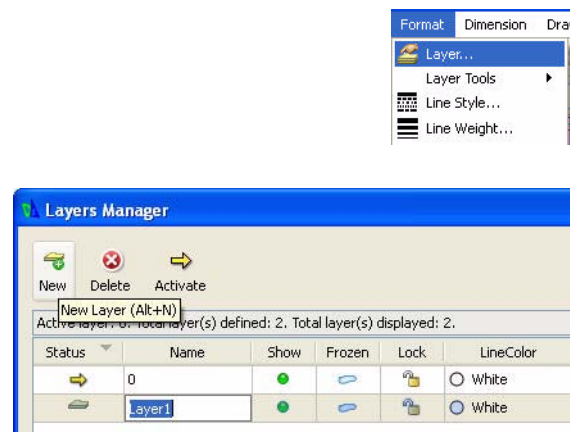

The Object Layer will inherit all of the properties of the default Layer 0.

#### 11 Create the Second New Layer

Click the **New Layer** icon.  The new default name is Layer 2.

Rename this Layer **Construction**.

*Construction* is the new Layer name.

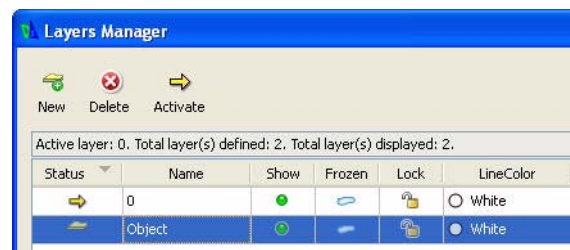

#### 12 Set the Second Layer LineColor.

New Layers are automatically assigned the LineColor white.

Double-click the **LineColor** cell for the Construction Layer.

Click **Red**.

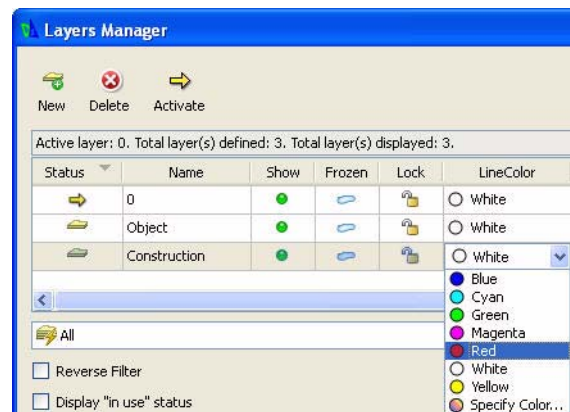

**13 Create the Second Layer LineStyle.**

Create a MM HIDDEN **LineStyle**.

Double-click the **LineStyle** cell from the Construction Layer.

Click **Other**. The **LineStyles Manager** dialog box is displayed.

Click the **Load** icon. 

The **Load LineStyles** dialog box is displayed

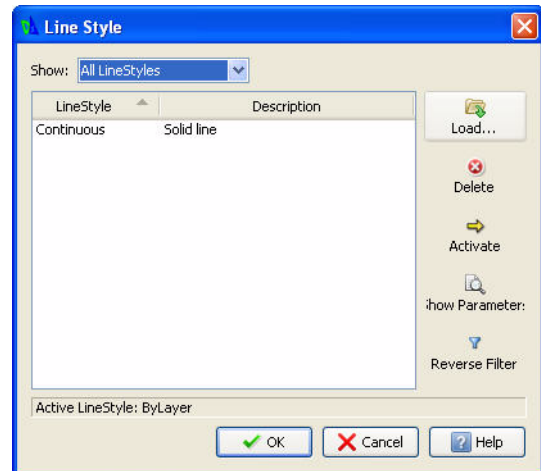
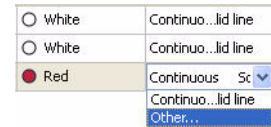
**NOTE:**

The default LineStyle file: `inch.lin`

Click the **Browse** button.

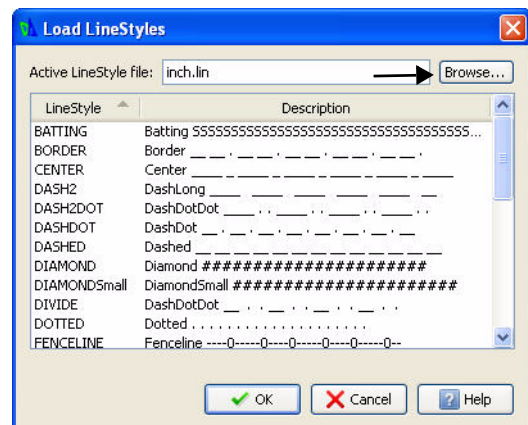

Select **MM.LIN** from the **Specify LineStyle File** dialog box.

Click **Open** from the **Specify LineStyles File** dialog box.

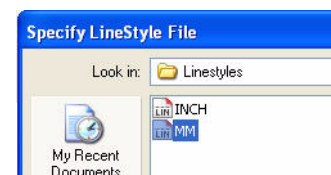

Select **HIDDEN** from the **Load LineStyles** dialog box.

Click **OK**.

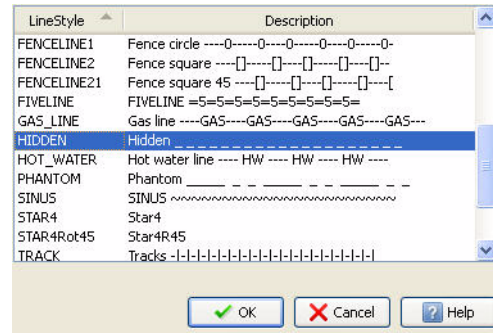

HIDDEN is added to the **LineStyle** dialog box.

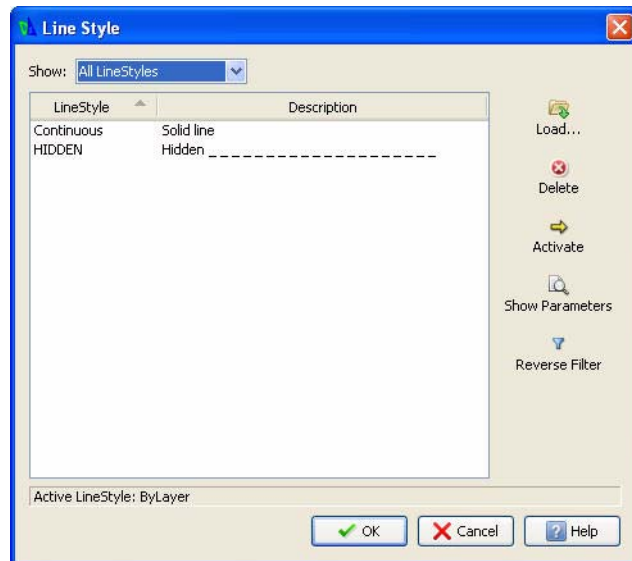

**14 Create the Second Layer LineStyle.**  
Create a MM CENTER LineStyle.

Click the **Load** icon. 

View the **Load LineStyles** dialog box.  
The default LineStyle file: `inch.lin`.

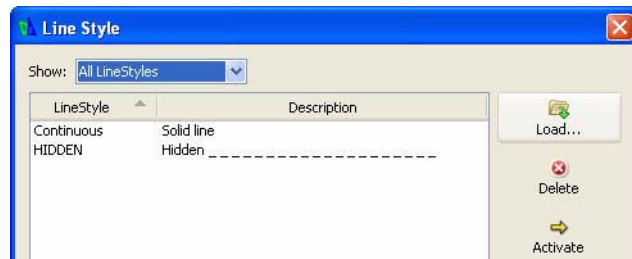

Click the **Browse** button.

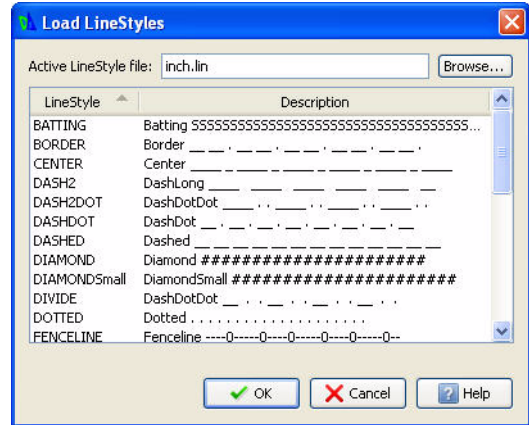

Select **MM.LIN** from the **Specify LineStyle File** dialog box.

Click **Open** from the **Specify LineStyles File** dialog box



Click **CENTER** from the **Load LineStyles** dialog box.

Click **OK**.

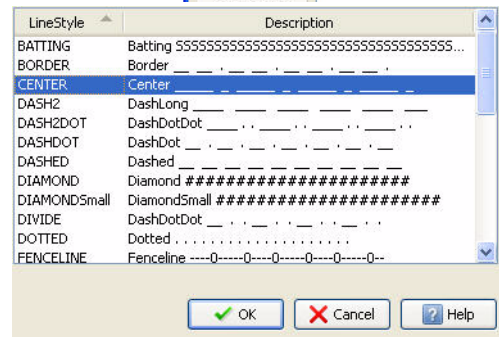

**CENTER** is added to the **Line Styles** dialog box.

Click **OK**.

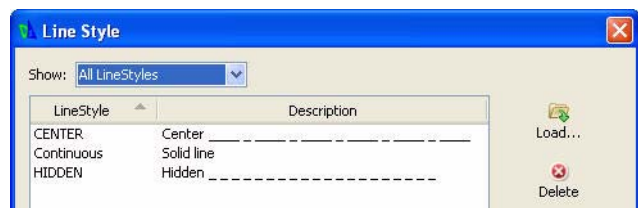

**15** Click **OK** from the **Line Style Dialog Box**.

**16** View the Available New LineStyles  
Double-click inside the **LineStyle** cell.

View the **HIDDEN** and **CENTER LineStyle** from the drop-down menu.

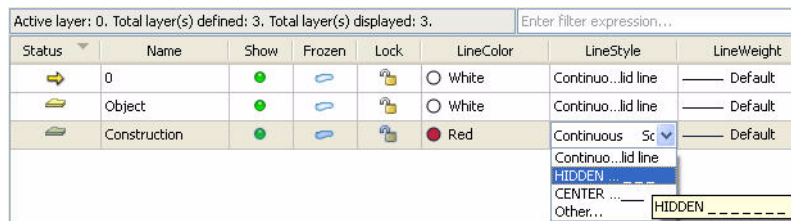

**17** Set **HIDDEN** for **LineStyle**.

Click **HIDDEN** in the **LineStyle** cell for the Construction Layer.

*HIDDEN* is the new the **LineStyle** for the Construction Layer.

Click **OK**.

**18 Save the Drawing.**

Click the **Save** icon  on the Standard toolbar.

**19 Create the Third New Layer.**

Click the **Layers Manager** icon  on the Layer toolbar.

The **Layers Manager** dialog box is displayed.

Click the **New Layer**  icon. The new default name is Layer1.

Rename this Layer **Centerline**.

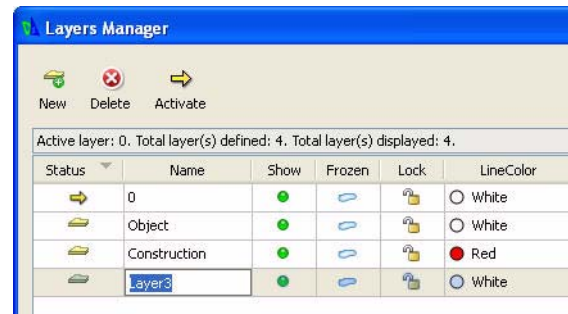

*Centerline* is the new Layer name.

Press the **Enter** key.

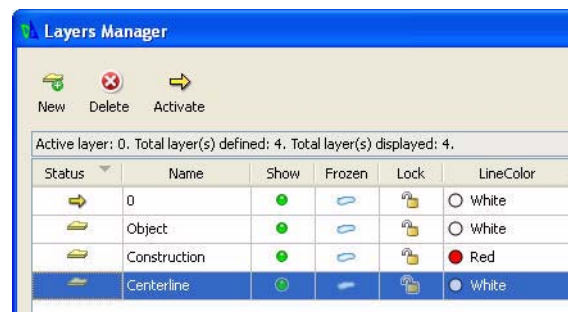

**20 Set the Third Layer LineColor.**

New Layers are automatically assigned the LineColor white.

Double-click the **LineColor** cell for the **Centerline** Layer.

Click **Blue**.

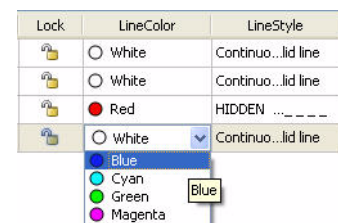

**21 Set the Third Layer LineStyle.**

Double-click the **LineStyle** cell for the Centerline Layer.

Click **CENTER**.

*CENTER* is new the **LineStyle** for the Centerline Layer.

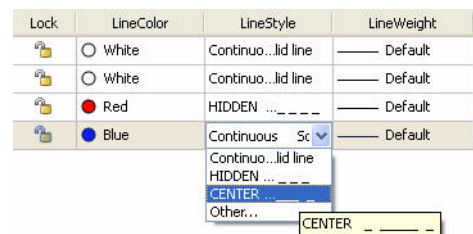

**22 Add a Description.**

Double-click inside the **Description** cell for the Centerline Layer.

Enter **Customer XYZ**.





Press the **Enter** key.

**NOTE:** At this time, the Default Layer is active.

### 23 Activate the Object Layer.

Double-click the icon in the **Status** box next to the Object Layer. A

➔ is displayed in the **Status** box.

*Object* is now the current Layer.

Click **OK**.

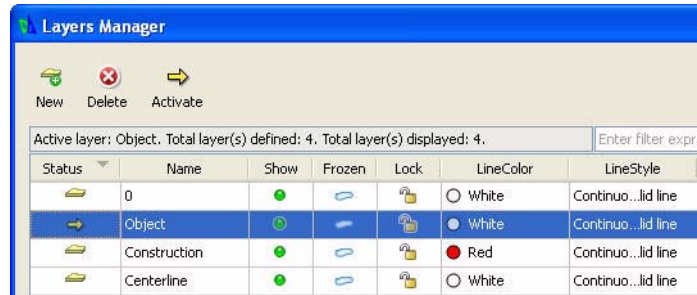

View the status of the Layers toolbar and the Properties Palette.



## Create the Second Drawing

### Rectangle Command

A rectangle drawn using the **Rectangle**  command is considered to be a single entity. If the same sized rectangle were drawn using the **Line** command, the resulting rectangle will be four individual unrelated Line entities.

### 24 Draw a Rectangle Entity.

Click the **Rectangle** icon  on the Draw toolbar.

Options: Chamfer, Elevation, Fillet, Thickness, Line Width or

Specify start corner»50,50┘

Options: Area, Dimensions, Rotation or

Specify opposite corner»150,150┘



**NOTE:** To specify the point coordinates with respect to the previous point (relative coordinate input, type the @ character in front of the coordinate value.

(@100,100 could be used as the relative value)

### 25 Draw a Circle Entity

Click the **Circle** icon  on the Draw toolbar.

Options: 3Point, 2Point, Itr, III, *Enter to exit* or  
Specify center point»70,70.↓

Options: Diameter or  
Specify radius»5.↓

**26 Turn Snap Off.**

Click the **Snap**  button on the Status bar.  
The command window displays: <Snap Off>.

**Pattern Command: Linear Option**

The **Pattern**  command provides the ability to create multiple copies of selected entities in a rectangular matrix or a polar, circular pattern. The created entities inherit all properties of the original entities such as Layers, and Layer custom properties.

**27 Create a Linear Pattern.**

Click the **Pattern** icon  on the Modify toolbar.

The **Pattern** dialog box is displayed.

Click the **Linear** button.

**Number of elements on Horizontal axis:** Enter **2**.

**Number of elements on Vertical axis:** Enter **2**.

**Spacing between elements on:**

**Horizontal axis:** Enter **60**.

**Vertical axis:** Enter **60**.

Click the **Select entities** icon.

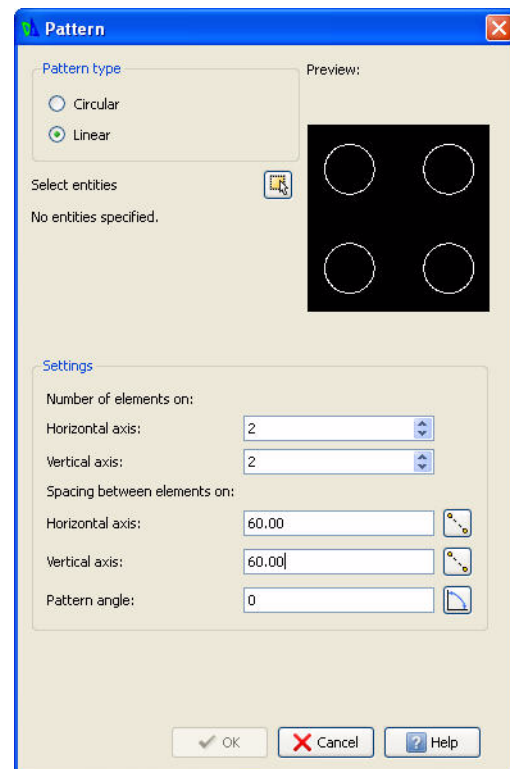

Select the circumference of the Circle on the screen.

1 found, 1 total

Specify entities».↓

Click OK.

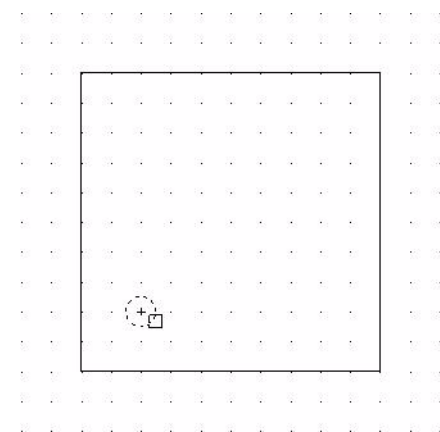



## Chamfer Command

The **Chamfer**  command allows you to connect two Lines with a beveled corner. The selected entities do not have to intersect, and they can overlap. If the entities overlap, they will be trimmed (by default) to create the beveled corner.

Since there are often non-symmetrical chamfers to be drawn, a chamfer distance from the corner of adjacent Lines can be specified for both of the intersecting entities. You can also define the connecting Line via a length and an angle.

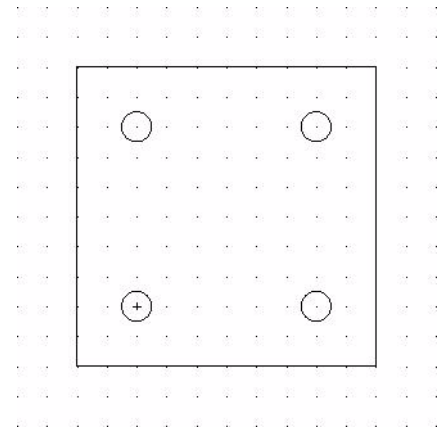

### 28 Create a Chamfer.

Create a 10mm multiple chamfer using the Distance trim mode option.

Click the **Chamfer** icon  on the Modify toolbar.

(TRIM mode) Active chamfer Di st1 = 0.00, Di st2 = 0.00

Options: Angle, Distance, mEthod, Multiple, Polyline, Trim mode, Undo or  
Specify first line» d ↵

Default: 0.00

Specify first distance: 10 ↵

Default: 10.00

Specify second distance: ↵

Options: Angle, Distance, mEthod, Multiple,  
Polyline, Trim mode, Undo or

Specify first line»m ↵

Options: Angle, Distance, mEthod, Multiple,  
Polyline, Trim mode, Undo or

Specify first line»

Click the lower left Vertical Line in the graphics area.

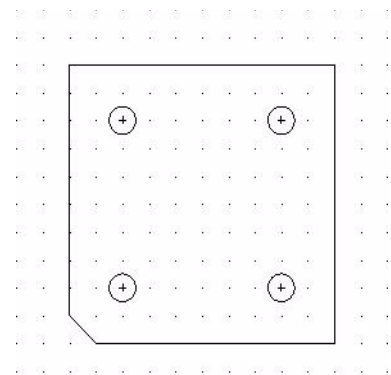

Options: *Shift+ select to apply corner* or

Specify second line ↵

Click the lower bottom Horizontal Line in the graphics area.

ptions: Angle, Distance, mEthod, Mul ti ple,  
Polyline, Irim mode, Undo or

Speci fy first li ne»

Repeat the above procedure for the three other corners.

Press **Esc** or **Enter** to exit.

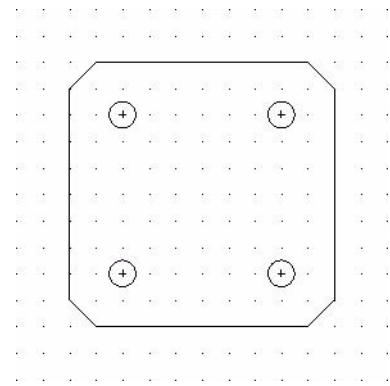

### NOTE:

Using the PolyLine option, all four corners will be chamfered at once.  
 The purpose of this book is to expose you to different methods and tools.

Command window

```
Specify first line» p
Specify polyline»
4 lines were chamfered
Options: Angle, Distance, mEThod, Multiple, Polyline, Trim mode, Undo or
Specify first line»
```

### 29 Draw a Center Circle Entity.

Draw a center Circle entity with a 30mm radius.

Click the **Circle** icon  on the Draw toolbar.

Opti ons: 3Poi nt, 2Poi nt, Itr, ITT, *Enter to exit* or

Speci fy center poi nt»100,100.↓

Defaul t: 5.00

Opti ons: Diameter or

Speci fy radi us»30.↓

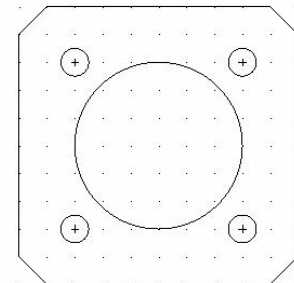

### 30 Draw a Circle Entity in the Right Quadrant.

Click the **Circle** icon  on the Draw toolbar.

Opti ons: 3Poi nt, 2Poi nt, Itr, ITT, *Enter to exit* or

Speci fy center poi nt»130,100.↓

Defaul t: 30.00

Opti ons: Diameter or

Speci fy radi us» 5.↓

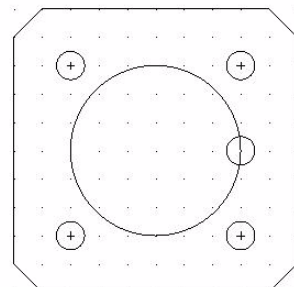

**31 Save the Drawing.**

Click the **Save** icon  on the Standard toolbar.

**Pattern Command: Circular Option**

The Pattern  command creates multiple copies of entities in a pattern (arranged in rows and columns, on a Circle, or on an Arc).

In the next section, you will create a circular pattern.

**32 Draw a Circular Pattern.**

Click the **Pattern** icon  on the Modify toolbar.

The Pattern dialog box is displayed.

Click the **Circular** button.

**Base pattern on:** set to **Fill Angle and Total Number of Elements**

**Fill angle:** Enter 360

**Total number:** Enter 6.

**Axis point X:** Enter 100.00.

**Axis point Y:** Enter 100.00

Click the **Select entities** icon.

Select the circumference of the small Circle that sits on the large Circle.

1 found, 1 total

Specify entities»

Click **OK**.

**33 Save the Drawing.**

Click the **Save** icon  on the Standard toolbar.

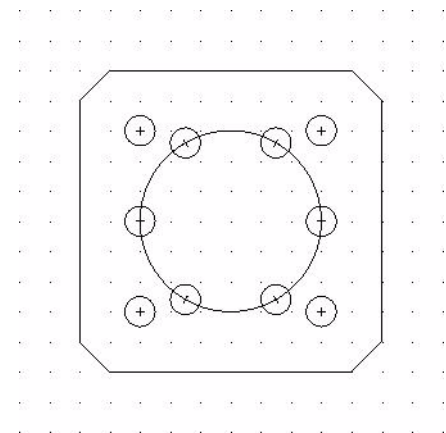
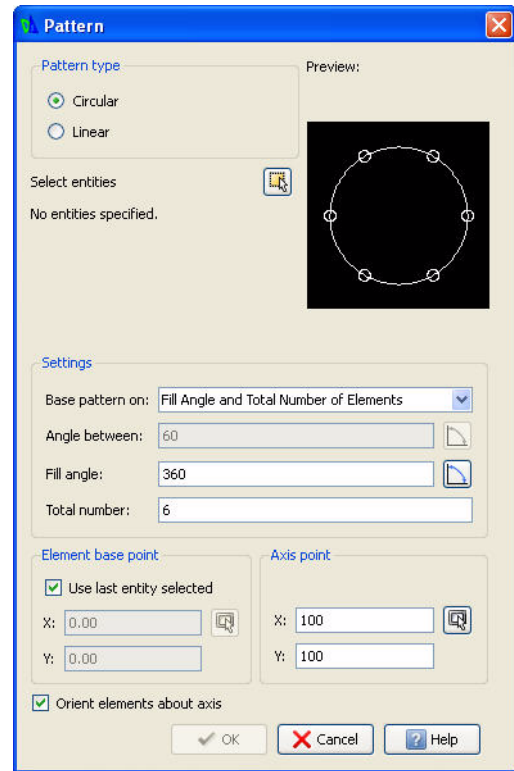

**34 Move the Large Circle to the Centerline Layer.**

Click the circumference of the large Circle in the graphics area.

Click the drop-down arrow from the **Layers Manager**.

Click Centerline.

Press **Esc** or **Enter** to exit.

**35 Save the Drawing.**

Click the **Save** icon  on the Standard toolbar.

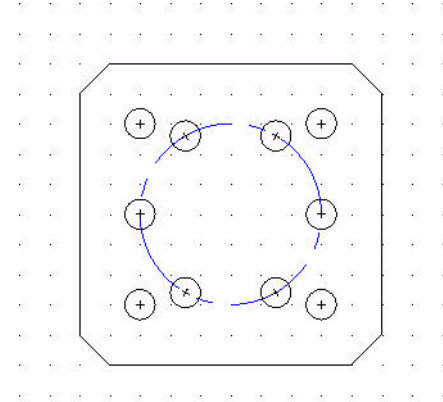
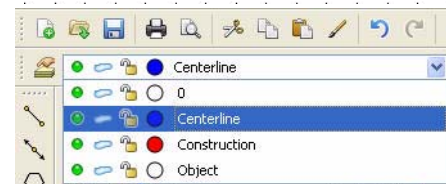
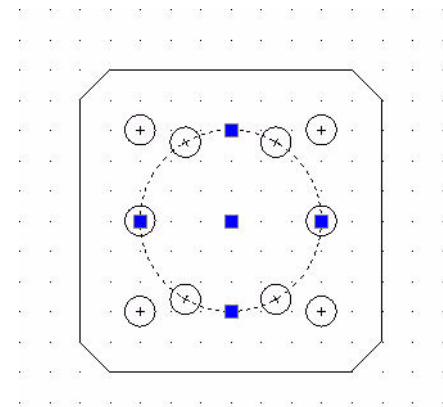
**Create the Third New Drawing**

Create two Layers. Use the **Circle (r)**, and **Circle (Ttr)** Draw tools.

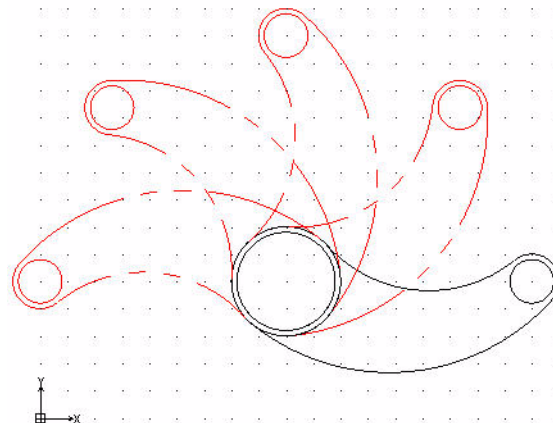
**NOTE:**

The **Circle (Ttr)** Draw command constructs a Circle from two tangent entities and the specified radius.

Apply the **Trim**, **Offset**, and **Pattern** (circular) modify commands,  
Create an Object and a Phantom Layer. Set custom properties.

### 1 Create a New Drawing.

Click the **New** icon  on the Standard toolbar.

## Drawing Template

### 2 Select a Default Drawing Template.

Double-click `standard.dwt` from the **Select Template** dialog box.

## Set the Drawing Environment

### Drawing Unit System

The default units system is the Decimal system and can be applied to either English (inches) or metric values (millimeters).

### 3 Set Linear Length Precision.

The **Unit System** section of the **Options - Drawing Settings** dialog box allows you to set the linear and angular unit formats.

Click **Format, Unit System...** from the Main Menu.

The **Unit System** portion of the **Options - Drawing Settings** dialog box is displayed.

Click **0.00** for **Precision** in the **Length** section of the dialog box.

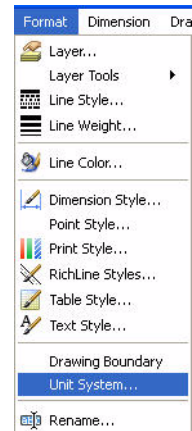

### 4 Set Linear Units Scale.

The **Units scale** section of the **Unit System** dialog box allows you to set the linear and angular unit formats.

Click **Millimeters** for **Block units format** in the **Units scale** section of the dialog box.

Click **OK**.

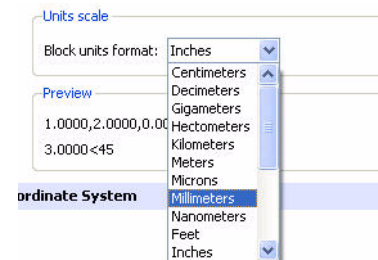

### Set Drawing Boundary

Use a horizontal A4 default drawing sheet.

### 5 Set Drawing Boundary.

Click **Format, Drawing Boundary** from the Main Menu.

Default: (0.00, 0.00)

Options: **Off**, **On** or

Specify lower left corner» 

Default: (12.00, 9.00)

Specify upper right corner» **297,210**

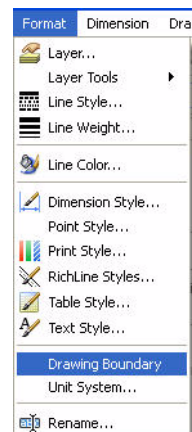

## Set Snap and Grid

Set the **Snap** and **Grid**. In this section the Grid and Snap spacing are equal.

### 6 Set Snap and Grid.

Click **Tools, Options** from the Main Menu.

The **Options** dialog box is displayed.

Click the **User Preferences** tab.

Expand **Drafting Options, Pointer Control** and **Snap Settings**.

Click the **Enable Snap <F9>** box.

Enter the value of **10** in the **Horizontal Snap spacing** box. Press the **Tab** key The **Vertical Snap spacing** box is updated.

Expand **Display** and **Grid Settings**

Click the **Enable Grid <F7>** box and the **Match Snap Spacing** box. The **Horizontal display spacing** value and the **Vertical display spacing** value will be set to **10.00**.

Click **OK**.

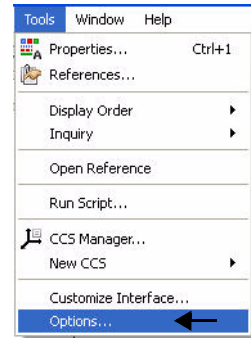

## Zoom Bounds

### 7 Display the Drawing with the New Boundary.

Drawing boundaries need to be used to adjusted to the current view.

### 8 Select View, Zoom, Bounds from the Main Menu.

### 9 Save the Drawing.

Click the **Save** icon  on the Standard toolbar.

Enter **File name:** Lesson 2-3.

Click **Save**.

## Create New Layers for the Drawing

In this section, you will create three new Layers called Object, Construction and Centerline. As well as apply custom properties.

### 10 Create the First New Layer.

Click the **Layers Manager** icon  on the Layers toolbar

The **Layers Manager** dialog box is displayed.

Click the **New Layer** icon.  The new default name is Layer 1.

Rename this Layer **Object**

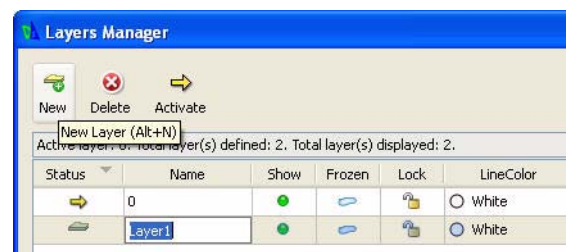





**NOTE:** The Default Layer and PHANTOM Layer is On.

## Construct a Circle from Two Tangent Circles and the Radius

### 16 Draw the First Circle Entity.

Draw a Circle from two tangent entities and the radius.

Click the **Circle** icon  on the Draw toolbar.

Options: 3Point, 2Point, Itr, III, *Enter to exit* or  
Specify center point»**90,50**↵

Options: Diameter or

Specify radius»**20**↵

### 17 Draw the Second Circle Entity.

: ↵

Options: 3Point, 2Point, Itr, III, *Enter to exit*  
or

Specify center point»**180,50**↵

Options: Diameter or

Specify radius»**10**↵

```
Command window
Options: 3Point, 2Point, Itr, III, Enter to exit or
Specify center point» 180,50
Default: 20.00
Options: Diameter or
Specify radius» 10
```

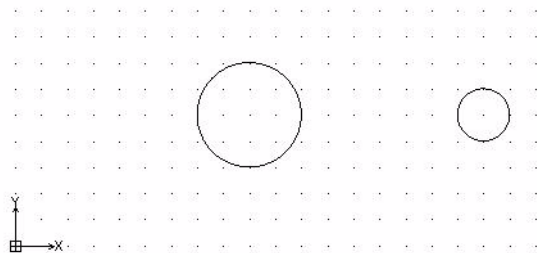



**18 Draw the Third Circle Entity.**

: ↵

Options: 3Point, 2Point, Itr, III, Enter to exit or

Specify center point»ttr.↵

Specify first tangency»

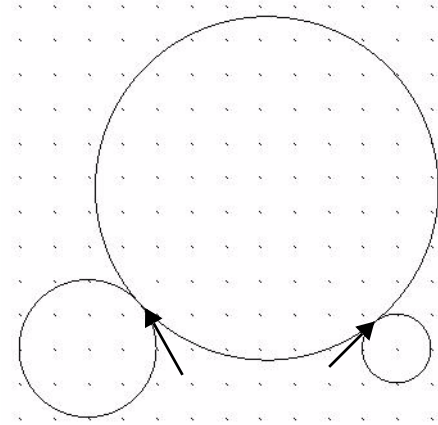
**19 Turn Snap Off.**Click the **Snap**  button on the Status bar. The command window displays: <Snap Off>.

Click the first tangent point on the left Circle as illustrated.

Specify first tangency»

Click the second tangent point on the right Circle.

Default: 10.00

Specify radius»50.↵

**20 Draw the Fourth Circle Entity.**

: ↵

Options: 3Point, 2Point, Itr, III, Enter to exit or

Specify center point»ttr.↵

Specify first tangency»

Click the first tangent point on the left Circle as illustrated.

Specify second tangency»

Click the second tangent point on the right Circle.

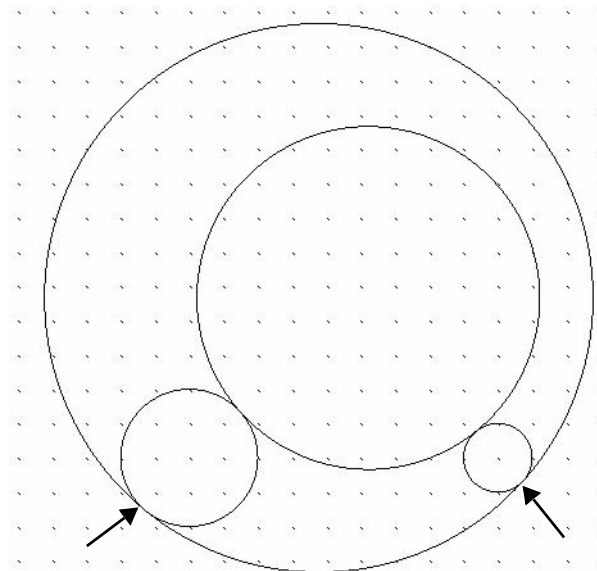

Default: 10.00

Specify radius»80.↵

**21 Save the Drawing.**Click the **Save** icon  on the Standard toolbar.**22 Trim the Top Circle.**Click the **Trim** icon  on the Modify toolbar.

Specify cutting edges...

Options: Enter to specify all entities or

Specify entities»↵

Options: Crossing, Crossline, Project, Edge, eRase, Undo, *Shift + select to extend* or

Specify segments to remove»

Click the top section of the 50mm Circle.

Options: Crossing, Crossline, Project, Edge, eRase, Undo, *Shift + select to extend* or

Specify segments to remove»

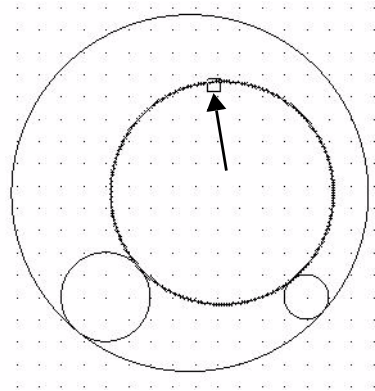

Click the top section of the 80mm Circle.

Options: Crossing, Crossline, Project, Edge, eRase, Undo, *Shift + select to extend* or

Specify segments to remove»↵

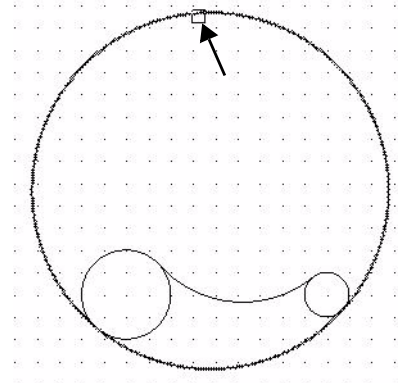

### 23 Save the Drawing.

Click the **Save** icon  on the Standard toolbar.

### Offset Command

The Offset  command provides the ability to create parallel shapes of Lines, PolyLines, Circles, Arcs, Ellipses, Elliptical Arcs, Splines, and InfiniteLines. A copy of a selected entity is placed at a specified distance from the original entity. The original entity stays in position.

### 24 Apply Offset to the Drawing.

Offset the two inside Circles.

Click the **Offset** icon  on the Modify toolbar.

Default: 1.00

Options: Del ete, Di stance, dest ination Layer, I through point or

Specify di stance»2↵

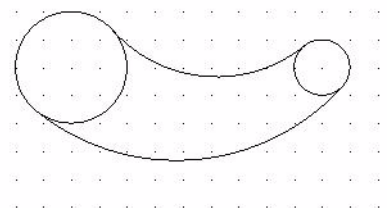

Default: Exit,

Options: Exit, Undo or

Specify source entity»

Click the circumference of the left Circle in the graphics area.

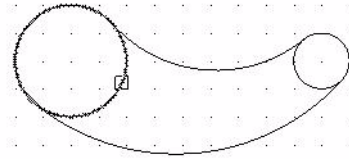

Default: Exit

Options: Both sides, Exit, Multiple, Undo or

Specify side for destination»

Click inside of the left Circle.

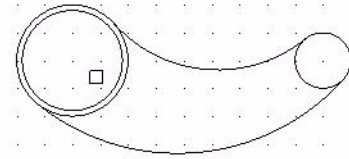

Default: Exit,

Options: Exit, Undo or

Specify source entity»

Click the circumference of the right Circle in the graphics area.

Default: Exit

Options: Both sides, Exit, Multiple, Undo or

Specify side for destination»

Click inside of the right Circle.

Specify source entity»

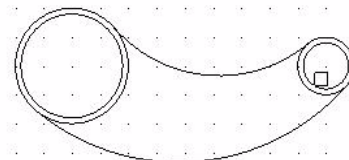
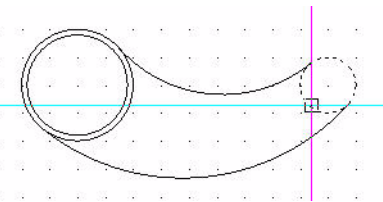

## 25 Trim the Drawing.

Trim the two inside Circles and two Arcs.

Click the **Trim** icon  on the Modify toolbar.

Specify cutting edges...

Options: *Enter to specify all entities* or

Specify entities»

Select the top Arc.

1 found, 1 total

Options: *Enter to specify all entities* or

Specify entities»

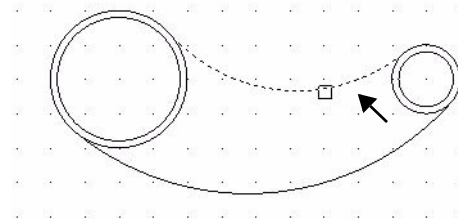

Select the bottom Arc.

1 found, 2 total

Options: *Enter to specify all entities or Specify entities»*

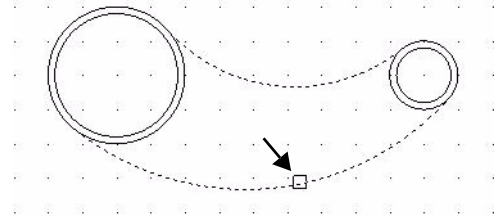

Options: *Crossing, CROSSLINE, Project, EDGE, ERASE, UNDO, Shift + select to extend or*

Specify segments to remove»

Click the right side of the left Circle.

Options: *Crossing, CROSSLINE, Project, EDGE, ERASE, UNDO, Shift + select to extend or*

Specify segments to remove»

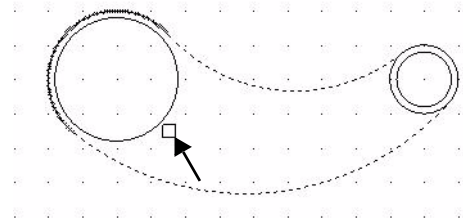

Click the left side of the right Circle.

Options: *Crossing, CROSSLINE, Project, EDGE, ERASE, UNDO, Shift + select to extend or*

Specify segments to remove»

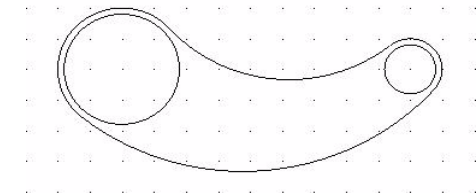
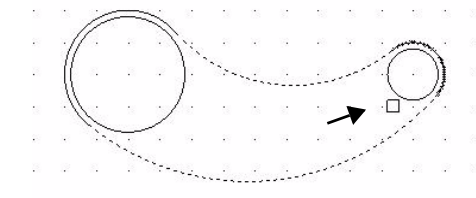

### Pattern Command: Circular Option

The Pattern  command creates multiple copies of entities in a pattern (arranged in rows and columns, on a Circle, or on an Arc). In the next section, create a circular pattern.

**26 Draw a Circular Pattern.**

Click the **Pattern** icon  on the Modify toolbar.

The **Pattern** dialog box is displayed.

Click the **Circular** button.

**Base pattern on:** set to **Select Fill Angle and Total Number of Elements**

**Fill angle:** Enter **180**.

**Total number:** Enter **5**.

Click the **Select entities** icon.

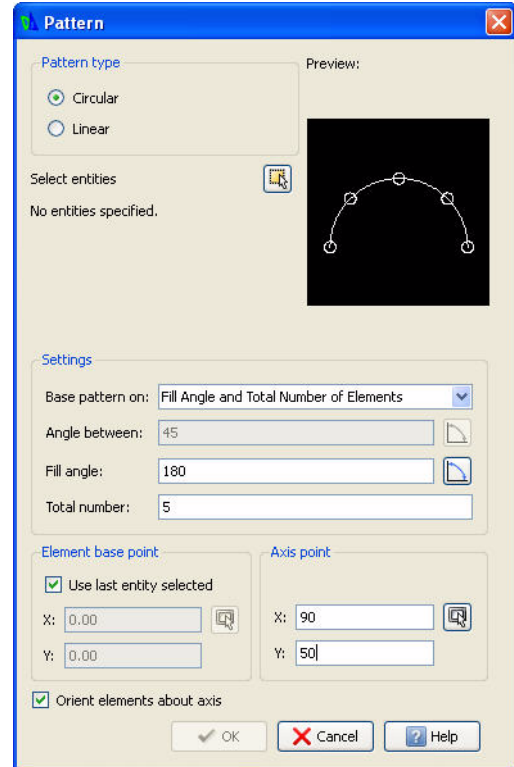

Specify entities»

Windows select all entities

6 found, 6 total »

Specify entities»↵

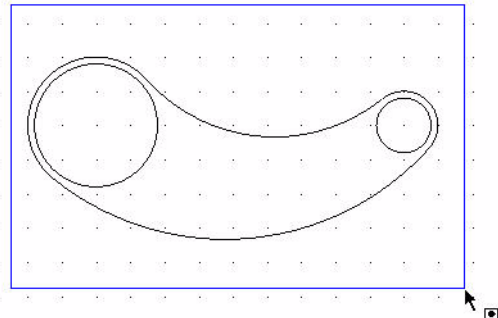

Click the **Axis Point** icon from the **Pattern dialog**

Specify pattern center point»

Click the center point of the large Circle in the graphics area.

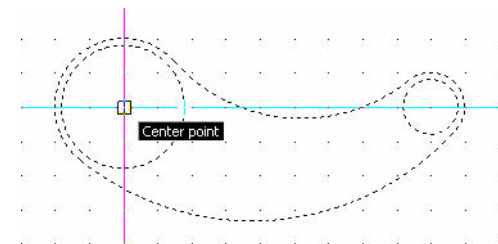

Click **OK**.

**27 Save the Drawing.**

Click the **Save** icon  on the Standard Toolbar.

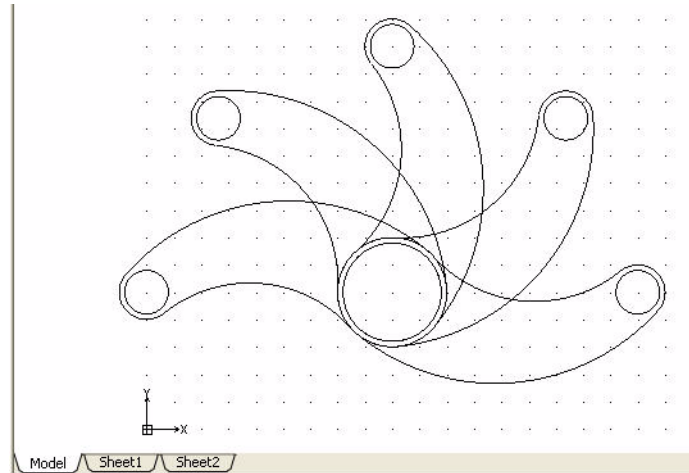

**28 Move Selected Entities to the Phantom Layer.**

Display the four circular pattern entities on the Phantom Layer.

Click the four circular pattern entities in the graphics area.

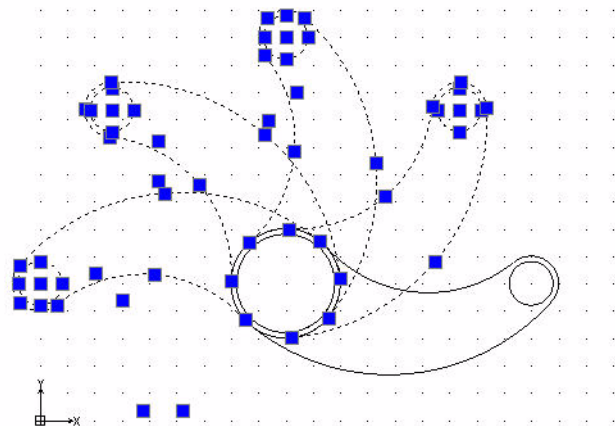

Click the drop-down arrow from the **Layers Manager**.

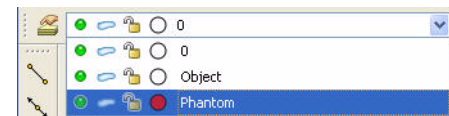

Click **Phantom**.

Press **Esc** or **Enter** to exit.

**29 Save the Drawing.**

Click the **Save** icon  on the Standard toolbar.

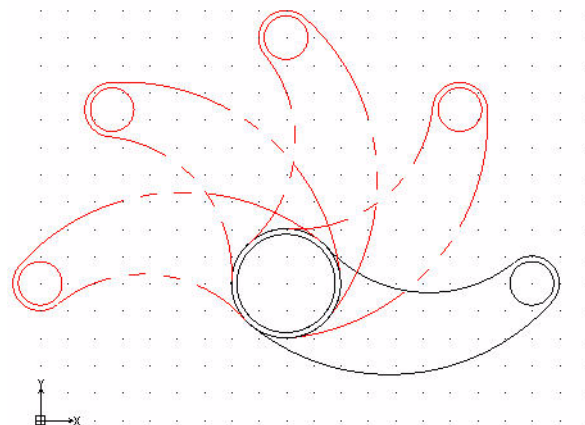

You are finished with this section.

## Lesson 3

# BASIC DIMENSIONING



When you complete this lesson, you will be able to:

- Create two drawings with custom layer properties
- Use absolute coordinates the command prompt and status bar
- Modify DimensionStyles and precision
- Edit Dimensions and Dimension text
- Measure and rotate an Aligned Dimension
- Apply the Move and Pattern Modify commands
- Insert, Modify and Create a Pattern of CenterMarks
- Apply the Linear, DimensionStyle, Angular, Radius, Aligned, DimensionEdit, DimensionTextEdit, Ordinate, Continue, and CenterMark Dimension commands
- Reset the Coordinate System

## Basic Dimensioning

During this lesson, you will rename a drawing, modify an existing drawing and apply Dimensions using absolute coordinates in the Command prompt and the graphics area.

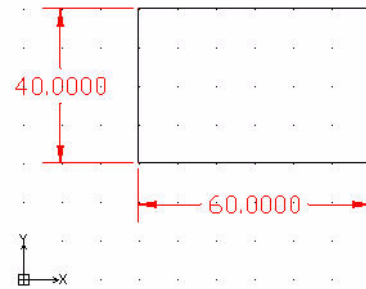

In the first drawing you will:

- Open an existing drawing from Lesson 1 (Lesson 1-3).
- Apply the **Save As** command and rename it Lesson 3-1.
- Create a new layer called Dimension with custom properties.
- Apply the **DimensionStyle**  command and the **Linear**  command to create a linear horizontal and vertical Dimension the Dimension layer.

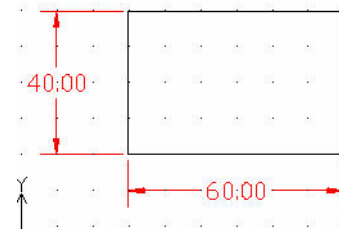

- Modify the precision of the two Dimensions.



- Apply the **Angular**  command to create an 80 degree Angular Dimension.
- Apply the **Aligned**  command to create an Aligned Dimension on the top right angular Line.

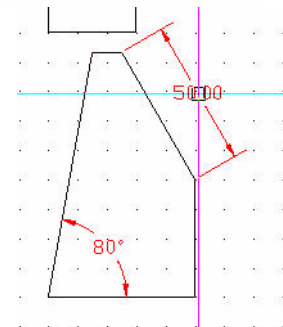

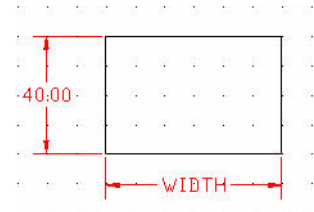

- Apply the **DimensionEdit**  command to modify the 60.00 Linear Dimension to the WIDTH text
- Measure the Aligned Dimension angle.





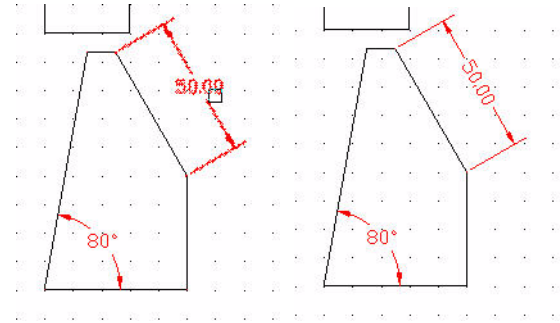



- Apply the **DimensionTextEdit**  command to rotate the 50.00 Aligned Dimension text match the angle of an entity.

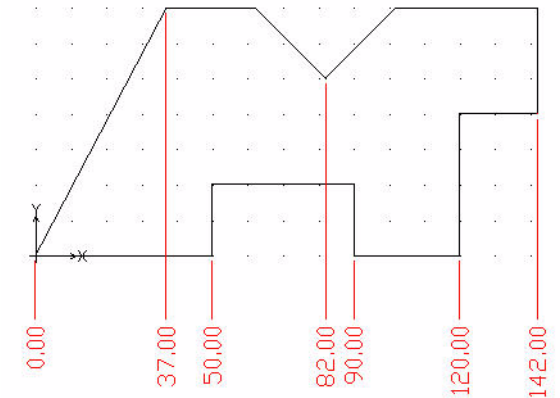

- Reset the coordinate system (CS) from the default position.
- Apply the **Ordinate**  command to apply Dimensions on the top entity.



In the second drawing you will:

- Open an existing drawing from Lesson 2 (Lesson 2-2)
- Create a new layer called Annotations with custom properties.
- Apply the **DimensionStyle**  command to set properties.
- Modify the default CenterMark size.
- Apply the **CenterMark**  command and insert CenterMarks on the Annotations layer in the drawing.
- Apply the **Pattern**  command to create a pattern of CenterMarks.
- Activate the Annotations layer.
- Apply the **Radius**  command to create a Radius Dimension.
- Modify the default precision setting.

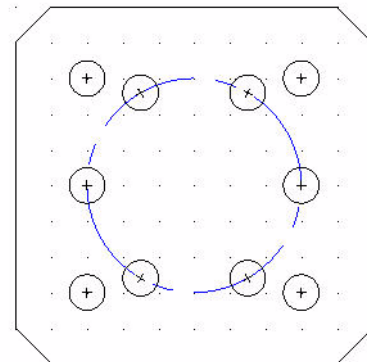
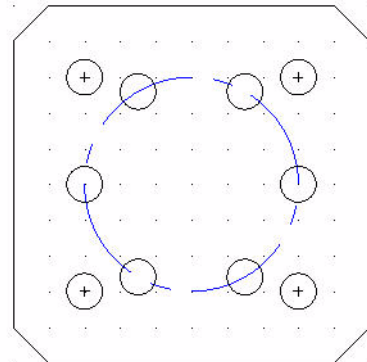

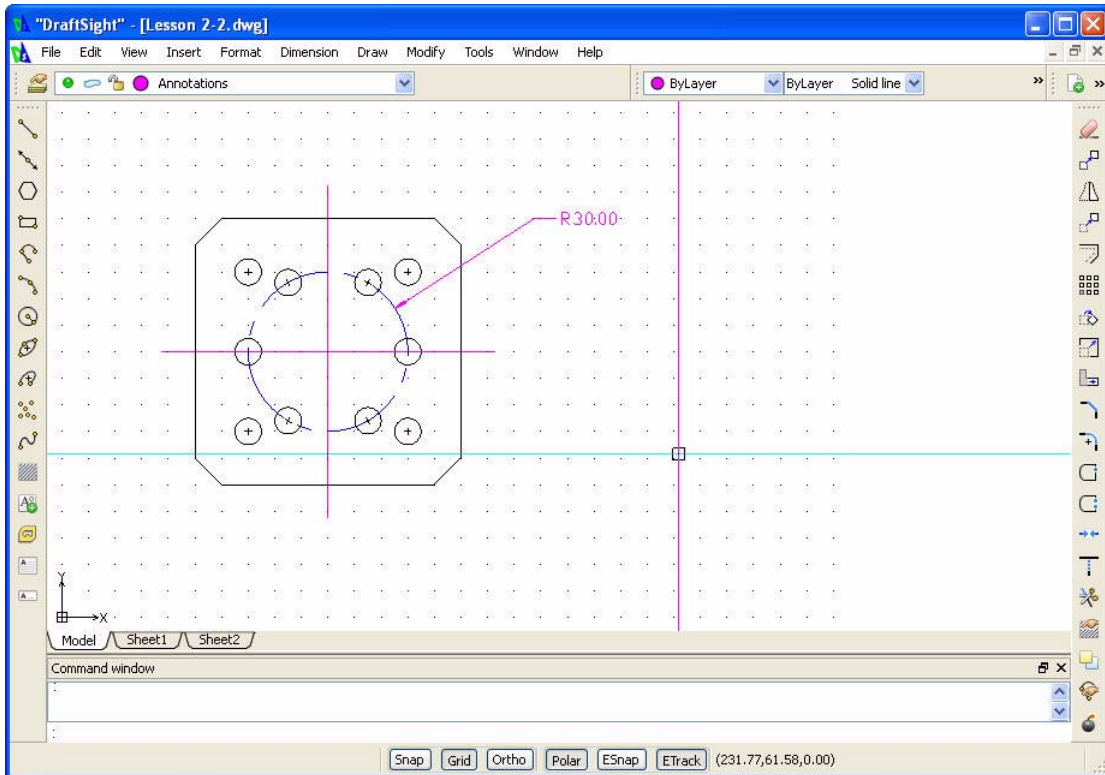

## Start a DraftSight Session

### 1 Start a DraftSight Session.

From the Windows Start menu, click **Start, All Programs, Dassault Systemes, DraftSight**.

## Dimension Toolbar

DraftSight provides a full range of Dimensioning tools and utilities. You can use a variety of Dimensioning tools to display measurements of entities or relations between them in your drawings.

By default, Dimensioning is associative. If you modify the geometry of drawing entities, Dimensions associated to them reflect the changes.

## Display the Dimension Toolbar.

### 2 Right-click the Main menu or a docked toolbar.

Click **Toolbars....** The **Specify Toolbars** dialog box is displayed.

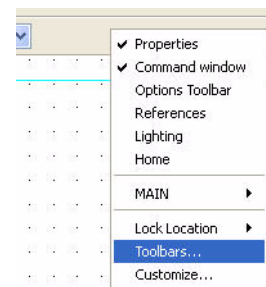

Check the **Dimension** box.

Click **OK**.

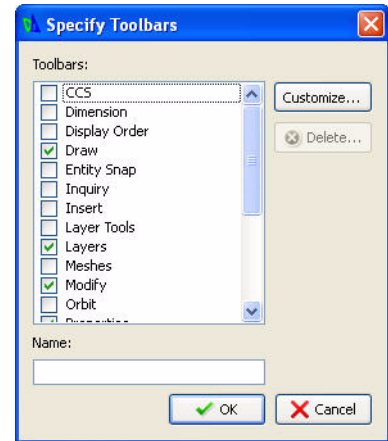



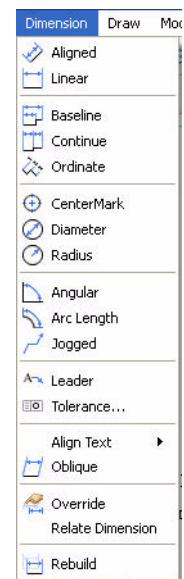













You can access the Dimension commands from the Dimension pull-down menu. Almost all of the Dimension commands are also found on the Dimension toolbar. Access on-line Help for detail information on all commands.



The following tools are available from the Dimension toolbar:



-  **Aligned:** (ParallelDimension) Creates an aligned Linear Dimension. Aligned Dimensioning is a type of Linear Dimensioning that measures and labels the absolute distance between two Points, regardless of the relative position of the axes. This lets you Dimension Lines, edges, or spaces, that are not located on the principal axes of the coordinate system, that is not parallel to the X or Y axes of the user coordinate system (UCS).
-  **Linear:**(LinearDimension) Creates a Horizontal, Vertical, or Rotated Dimension.
-  **Baseline:** (BaselineDimension) Creates a series of Parallel Linear Dimensions that share the same baseline. Baseline Dimensioning allows you to read the cumulative Dimension between two end points, extending over a number of individual Dimensions within a chain.

-  **Continue:** (ContinueDimension) Continues a Linear, Angular, or Ordinate Dimension from the second Extension Line of the previous or a selected Dimension. Continuous Dimensioning allows one long Dimension to be broken into shorter segments that add up to the total measurement.
-  **Ordinate:** (OrdinateDimension) Creates ordinate Point Dimensions. The command displays an X or Y coordinate with a Leader Line to create X-datum or Y-datum Dimensioning. The value of the X or Y coordinate is defined by the Point you specify, called feature position.
-  **CenterMark:** (centermark) Creates a Center Mark or Center Lines of Circles and Arcs. Center marking is used to position a mid point mark (+) or broken Lines crossing at the center of a Circle or an Arc.
-  **Diameter:** (DiameterDimension) Creates diameter Dimensions for Circles and Arcs. Unlike the Linear Dimensioning applied on Circles (which also display the diameter), no Dimension Lines are shown. The command creates a single Leader Line to show the relationship between the value and the entity itself.
-  **Radius:** (RadiusDimension) Creates radial Dimensions for Circles and Arcs. Radius Dimensioning is carried out in the same way as diameter Dimensioning, the only difference being that a radius Dimension is calculated instead of a diameter measurement.
-  **Angular:** (AngleDimension) Creates an Angular Dimension. The command lets you create the Dimension of both the interior angle between the two legs and of the exterior angle.
-  **Arc Length:** (ArclengthDimension) Creates an Arc Length Dimension. It measures the distance along an Arc or PolyLine Arc segment. To differentiate Arc Length Dimensions from Linear or Angular Dimensions, an Arc symbol is displayed with the Dimension text.
-  **Jogged:** (JoggedDimension) Creates jogged radius Dimensions for Circles and Arcs. Jogged Leader Lines are typically used when a sheet is too small to display the true center point of a Radial Dimension.
-  **Leader:** (leader) Creates Leader Lines that connect annotations to a drawing entity. Creating a Leader is often useful when the Dimension text or annotation does not fit next the drawing entity it measures or describes.
-  **Tolerance:** (tolerance) Creates tolerances (datum indicators and Basic Dimension notation).
-  **Dimension Edit:** (EditDimension) Changes the position and the angle as well as the value of Dimension text. In addition, you can modify the orientation of the Dimension Extension Lines.
-  **Dimension Text Edit:** (EditDimensionText) Moves and rotates Dimension text of a single Dimension entity. The default sequence of the command lets you position Dimension text dynamically.
-  **Dimension Rebuild:** (RebuildDimension) Applies the stored Dimension system variable settings to selected Dimensions. Unlike text styles, DimensionStyles do not automatically update when the style is changed. Note that the Dimension update permanently overrides DimensionStyles previously applied to the selected entity.

-  **Dimension Style:** (DimensionStyle) Creates and modifies DimensionStyles  
DimensionStyles are the main method used to control the way Dimensions look

## Dimension Terminology

### Dimension Line

The Dimension Line is normally offset for clarity from the measured feature. The Dimension Line indicates the direction and length of the measured distance. Dimension Lines are usually terminated with arrows. Angular Dimension Lines become Arcs whose centers are at the vertex of the angle.

### Arrow

The arrow is a mark at the end of a Dimension Line. The arrow indicates its termination. DraftSight provides the ability to apply various shapes other than arrows in some styles.

### Extension Line

Extension Lines, sometimes called witness Lines indicate the offset of the Dimension Line from the measured feature. Normally Extension Lines are perpendicular to the direction of the measurement.

### Dimension Text

The Dimension text can consists of words, characters, numbers, and symbols used to display the measured type and value of the Dimension. Dimension text format conforms to the same linear and angular units as the default of the drawing. The text style conforms to the current text style.

### Leader

The Leader is a radial Line used to Point from the Dimension text to the Arc or Circle whose diameter or radius is being Dimensioned.

### Center Mark

The center mark is used to position a mid point mark (+) or broken Lines crossing at the center of a Circle or an Arc.

## Open an Existing Drawing

- 3 Click the **Open** icon  on the Standard toolbar.  
The **Open** dialog box is displayed.

- 4 Double-click **Lesson 2-3**. The drawing is displayed in the graphics area.

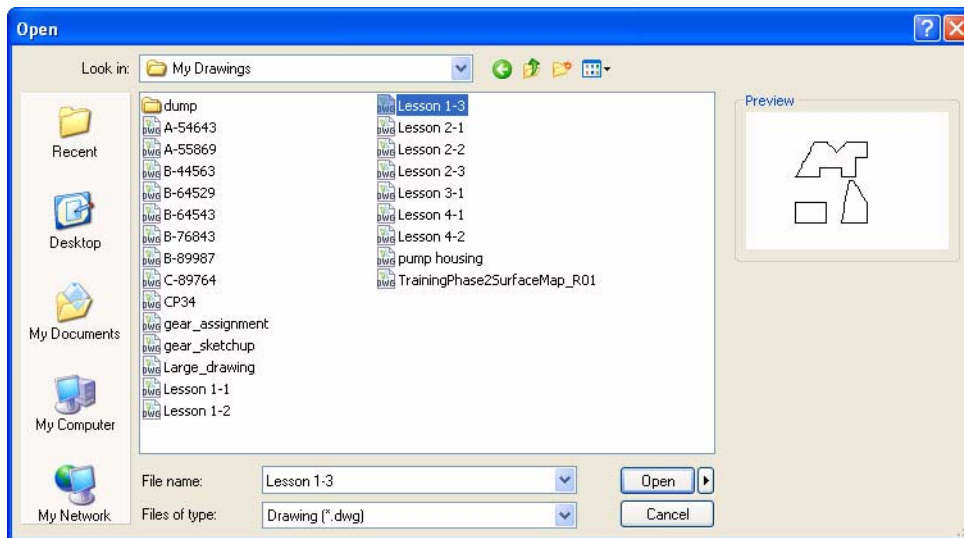

- 5 **Save the Drawing.**  
Click **File, Save As** from the Menu bar.  
Enter **File name:** Lesson 3-1.  
Click **Save** from the **Save As...** dialog box.



**NOTE:**

Use the **Save As** command to save the drawing under a different name or in a different location.

### Create a New Layer

In this section, create a new layer called **Dimension** with custom properties.



- 6 **Create a new Layer.**  
Click the **Layers Manager** icon.  The **Layers Manager** dialog box is displayed.  
Click the **New Layer** icon.  The new default name is **Layer 1**.  
Rename this layer **Dimension**.  
*Dimension* is the new layer name.

- 7 Set the LineColor.**  
Double-click the **LineColor** cell for the Dimension layer.  
Click **Red**.

Status	Name	Show	Frozen	Lock	LineColor
→	0	●	☞	🔒	○ White
📁	Object	●	☞	🔒	○ White
📁	Phantom	●	☞	🔒	● Red
📁	Dimension	●	☞	🔒	○ White

Active layer: 0. Total layer(s) defined: 4. Total layer(s) displayed: 4.

Enter filter expression

White  
 Red  
 Blue  
 Cyan  
 Green  
 Magenta  
 Yellow

**NOTE:** By default, *Continuous* LineStyle is selected.

- 8 Activate the Dimension Layer.**  
Click the **Dimension** layer in the Layers Manager dialog box.  
Click the **Activate Layer** button. A yellow arrow is displayed in the Dimension **Status** box.
- 9 Close the Layers Manager Dialog box.**  
Click **OK**.

Status	Name	Show	Frozen	Lock	LineColor	LineStyle
→	0	●	☞	🔒	○ White	Continuo...lid line
📁	Defpoints	●	☞	🔒	○ White	Continuo...lid line
📁	Object	●	☞	🔒	○ White	Continuo...lid line
📁	Phantom	●	☞	🔒	● Red	CENTER ...
→	Dimension	●	☞	🔒	○ White	Continuo...lid line

Active layer: Dimension. Total layer(s) defined: 5. Total layer(s) displayed: 5.

Enter filter expression

New Delete Activate

- 10 Save the Drawing.**  
Click the **Save** icon  on the Standard toolbar.

## Working with Dimensions

DimensionStyles are the main method used to control the way Dimensions look. You create and manage DimensionStyles by using the **DimensionStyles Manager** dialog box.

### Dimension Styles Manager Dialog Box

Use the style name, input and selection dialog to either store the current settings as a Dimensioning style, or to select a predefined style as the default.

### DimensionStyle Command

The **DimensionStyle**  command on the Dimension toolbar provides the ability to create and modify DimensionStyles. Remember, DimensionStyles are the main method used to control the way Dimensions look.

- 11 Set DimensionStyle**  
Click the **DimensionStyle** icon  on the Dimension toolbar.

The **Options - Drafting Styles** dialog box is displayed with the **Dimensions** option expanded.



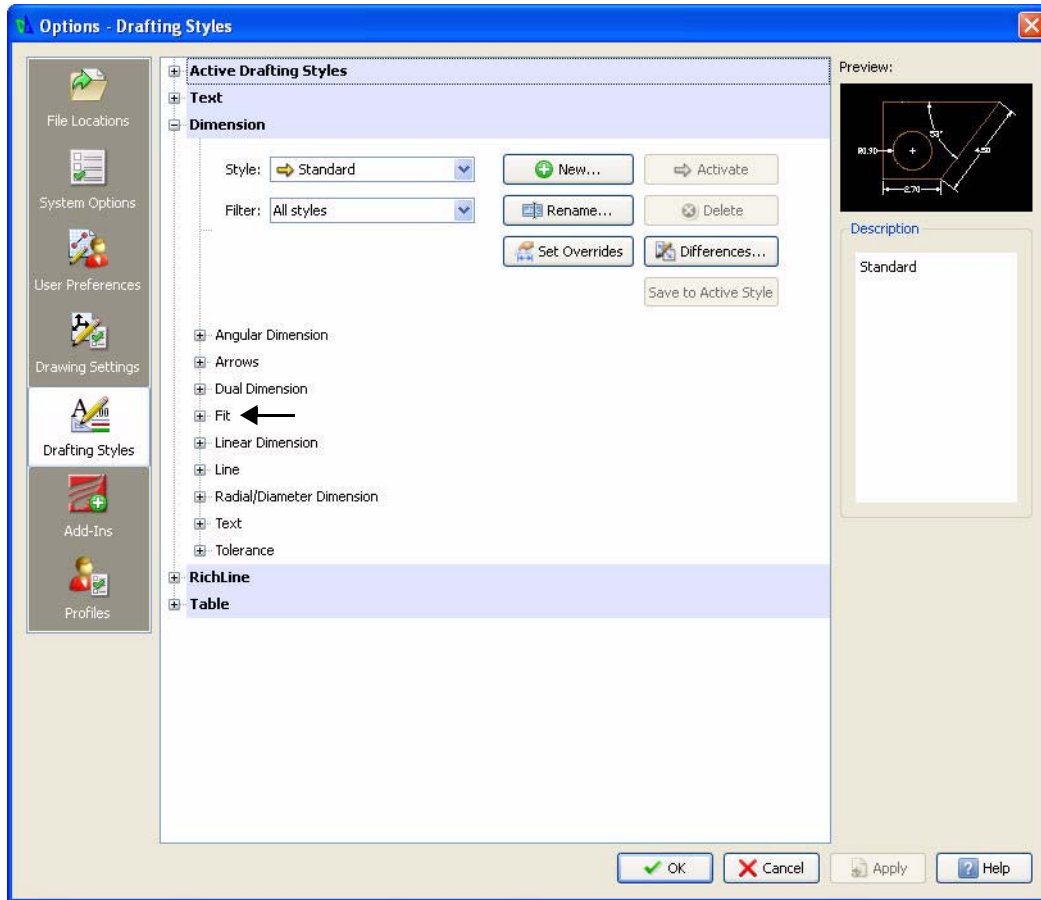

Expand the **Fit, Dimension scale** option.

View the **Fit** options displayed on the right side of the dialog box.

**Scale factor:** Enter 25.

Click **OK**.

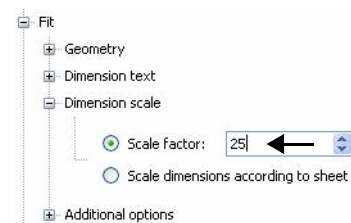

### Linear Command

The **Linear**  command creates a horizontal, vertical, or rotated Linear Dimension.

One way to use the Linear command is to define two Points of measurement which are the origins of the Extension Lines.

The Command prompt also offers you to select an entity to be Dimensioned. Press Enter (↵) at the prompt of the command.

You are then requested to select a drawing entity to be Dimensioned. Lines, PolyLines, Circles and Arcs can be selected. The start and end points of linear entities, or the diameter of the circular entities are evaluated for the measurement.

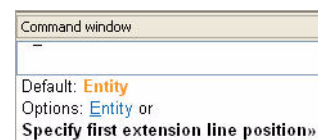

Once the Points of measurement are defined, you are prompted to indicate the position for the Dimension Line.



The distance between the two Points is measured along the X axis for a Horizontal Dimensioning and along the Y axis for a Vertical Dimensioning. For oblique measurements the Rotated option is provided.

The measurement is placed as Dimension text based on the definitions of the current DimensionStyle.

### Create Two Linear Dimensions

Dimension the rectangle in the graphics area. Create a Horizontal and Vertical Dimension.

#### 12 Create a Horizontal Dimension.

Click the **Linear** icon  on the Dimension toolbar.

Default: Entity

Options: Entity or

Specify first extension line position»

Click the **lower left** end point of the rectangle.

Specify second extension line position»

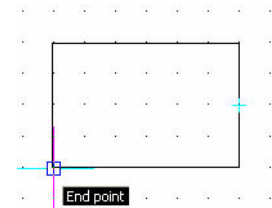

Click the **lower right** end point of the rectangle.

Options: Angle, Horizontal, Note, Rotated, Iext, Vertical or

Specify Dimension Line position»

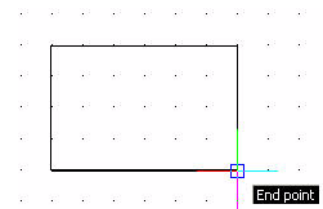

Click a **position** about one grid below the bottom Horizontal Line.

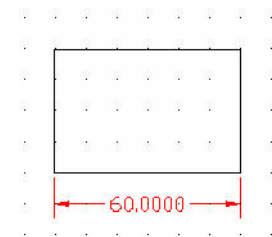

#### NOTE:

The **Note** option provides the ability to modify the Dimension text using the Note editor dialog box.

**13 Create a Vertical Dimension.**

: ↵

**TIP:** Press the Enter key (↵) to repeat the command.

Default: Entity  
 Options: Entity or  
 Specify first extension line position»

Specify entity»

Click the left Vertical Line of the rectangle.

Options: Angle, Horizontal, Note, Rotated, Text, Vertical or  
 Specify Dimension Line position»

Click a position about two grid spaces to the left of the left Vertical Line. The rectangle now has a Vertical and Horizontal Dimension.

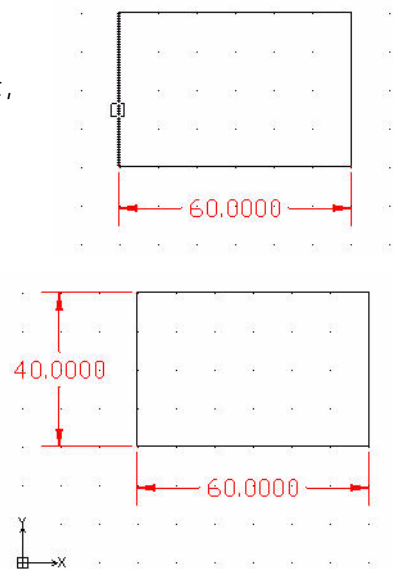

**NOTE:** The **Angle** option changes the angle of the dimension text.

**Modify Dimension Precision Display**

The present Vertical and Horizontal Dimensions display four decimal places. Modify the precision of the Dimensions.

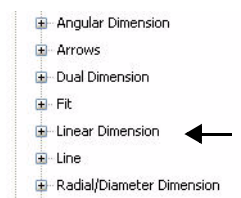

**14 Modify Dimension Precision.**

Click the **DimensionStyle** icon  on the Dimension toolbar. The **DimensionStyles Manager** dialog box is displayed.

Expand the **Linear Dimensions** option.

View the Linear Dimensions options displayed on the right side of the dialog box.

**Precision:** Select **0.00** from the drop-down menu.

Click **OK**.

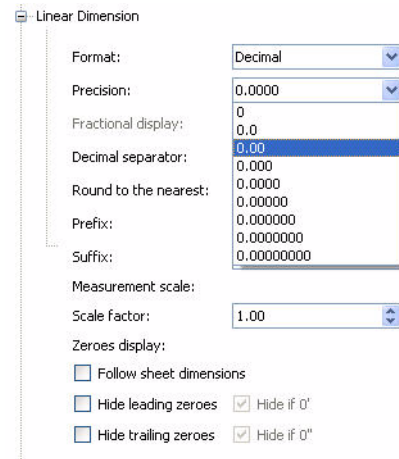
**15 Save the Drawing.**

Click the **Save** icon  on the Standard toolbar.

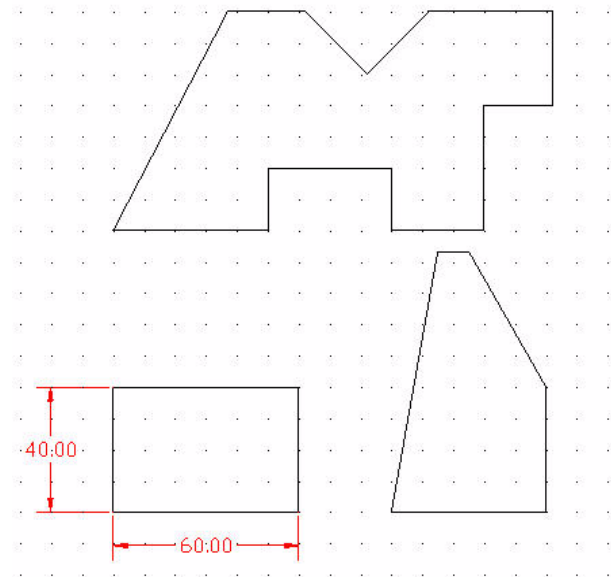

## Angular Command

The **Angular**  command provides the ability to Dimension angles in your drawing. The tool creates the Dimension of both the interior angle between the two legs and of the exterior angle using various methods:

- Three Points: (vertex/point/point)
- Between two nonparallel Lines
- On an Arc between the two end points of the Arc, with the center as the vertex
- On a Circle, between two Points on the Circle, with the center as the vertex

### Create an Angular Dimension

Create an 80 degree Angular Dimension.

#### 16 Create an Angular Dimension.

Click the **Angular icon**  from the Dimension toolbar.

Options: *Enter to specify vertex or  
Specify entity»*

**NOTE:** Be sure the **SNAP** is set to off. Click the **Snap** button on the status bar.

View the The command window for the display: <Snap Off>.

Click the Horizontal Line as illustrated.

Specify second line»

Click the left bottom Angular Line.

Options: Angle, Note, Text or  
Specify dimension position»

Click a position inside the entity as illustrated.

#### 17 Save the Drawing.

Click the **Save icon**  on the Standard toolbar.

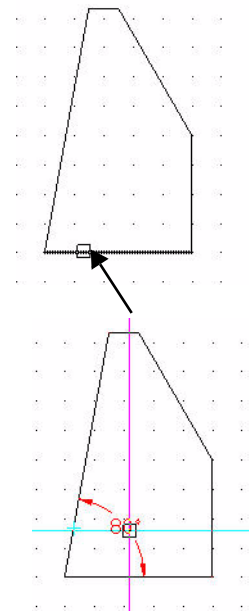

## Aligned Command

The **Aligned**  command provides the ability to create an aligned Dimension. Aligned Dimensioning is a type of linear Dimensioning that measures and labels the absolute distance between two Points.

### Create an Aligned Dimension

Create an aligned Dimension on the top right Angular Line.

#### 18 Create an Aligned Dimension.

Click the **Aligned** icon  on the Dimension toolbar.

Default: Entity

Options: Entity or

Specify first extension line position»

Click the bottom right end point of the right side Diagonal Line as illustrated.

Specify second extension line position»

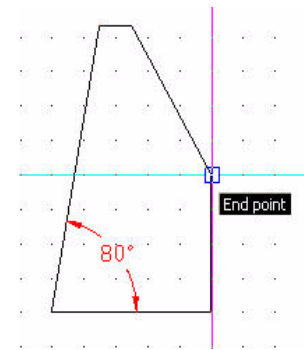

Click the top left end point of the right Diagonal Line as illustrated.

Options: Angle, Note, Text or

Specify dimension line position»

Place the Dimension.

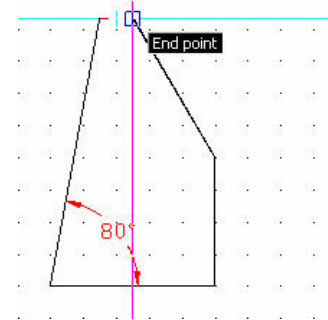

Click a position above the Line as illustrated.

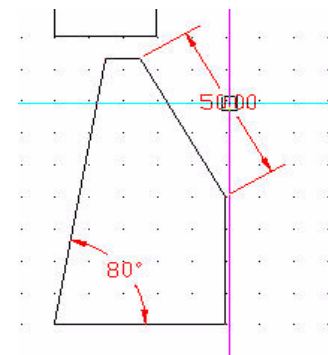

### Edit Dimensions and Dimension Text

DraftSight provides several Dimensioning commands which allows you to edit or format the Dimension text during the creation of the current Dimension.

DimensionEdit Command

The **DimensionEdit**  command provides the ability to replace the Dimension text with new text, rotate the existing text, move the text to a new position, and if necessary, restore the text back to its home position. Home position is the position defined by the current style. In addition, the provided options allow you to modify the angle of the Extension Lines, normally perpendicular relative to the direction of the Dimension Line (**Oblique**) option.



DimensionTextEdit Command

The **DimensionTextEdit**  command provides the ability to move and rotate Dimension text of any single Dimension entity.

The default sequence of the (DimTextEdit) command lets you position Dimension text dynamically.

After calling the command, select a Dimension entity. Then point to the drawing to determine the new position of the Dimension text.

Dimension Text Alignment Options

- The **Angle** option rotates the Dimension text about its center by the angle you specify.
- The **Center** option moves the text to a left justified position within the Dimension.
- The **Reset** option undoes the move of Dimension text and returns it to the original position.
- The **Left** option moves the text to a left justified position within the Dimension.
- The **Right** option moves the text to a left justified position within the Dimension.

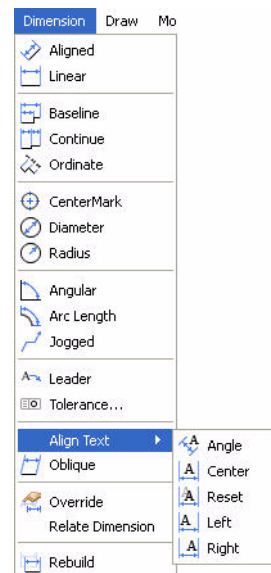

Modify the Linear Dimension Text

Modify the 60.00 Linear Dimension to **WIDTH** text.

19 Modify the Linear Dimension Text.

Click the **DimensionEdit** icon  on the Dimension toolbar.

Use the **New** option.

Default t: Home

options: Angle, Home, New, Obl i que or

Speci fy opti on»n.↓

Speci fy new Di mensi on Text: **WIDTH** ↓

Speci fy di mensi on(s)»

Click the **60.00** Dimension text as illustrated.

1 found, 1 total

Specify dimension(s) »

## 20 Undo the Modified Linear Dimension.

: U

## 21 Save the Drawing.

Click the **Save** icon  on the Standard toolbar.

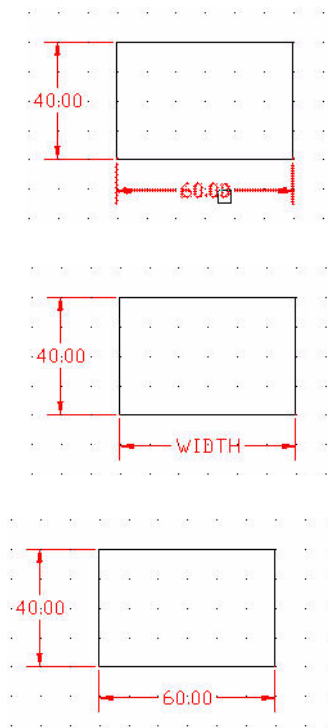

## Measure and Rotate an Aligned Dimension

First measure the Aligned Dimension angle. Rotate the 50.00 Aligned Dimension text to match angle of the entity.

## 22 Measure the Aligned Dimension Angle.

Click **Tools, Inquiry, Get Distance** from the Main Menu.

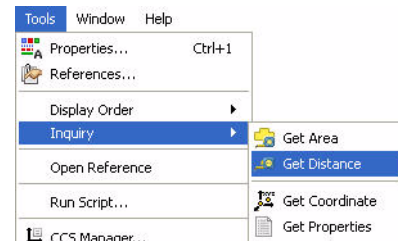

### NOTE:

Make sure the EntitySnap function is set to ON. Click the **ESnap** button on the Status bar.

View the command window: <ESnaps On>.

Specify start point»

Click the top left end point of the Aligned Dimension.

Specify end point»

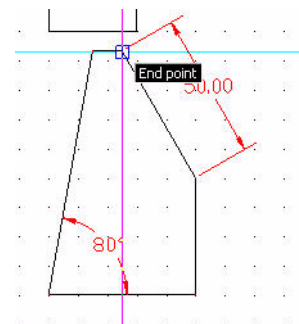

Click the bottom right end point of the Aligned Dimension.

View the angle in the XY Plane in the command window:

Distance = 50.00, Angle in XY Plane = 300, Angle from XY Plane = 0

Delta X = 25.00, Delta Y = -43.30, Delta Z = 0.00

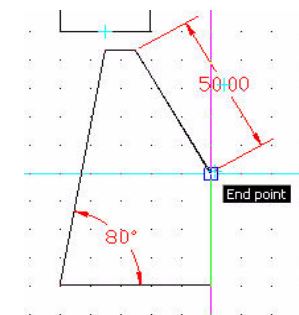

**NOTE:** Angle in XY Plane is 300.

**23 Rotate the Aligned Dimension Text.**

Click the **DimensionTextEdit** icon  on the Dimension toolbar.

Specify dimension»

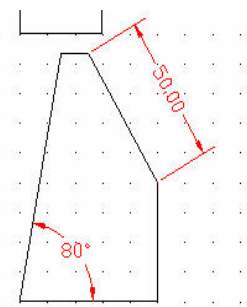

Click the **50.00** aligned Dimension text as illustrated.

Default: (174.29, 101.34, 0.00)

Options: Angle, Center, Home, Left, Right or

Specify new text position» **a** ↵

Specify angle for Dimension Text: **300** ↵

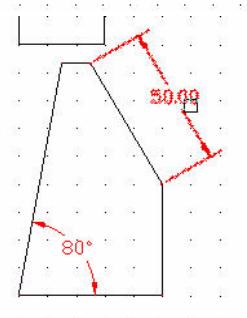



## Move Command

Apply the **Move**  command to reposition drawing entities within the coordinate system without changing their orientation or size.

### 24 Move the Selected Entities.

Click the **Move** icon  on the Modify toolbar.

Specify entities»

Select all 7 entities as illustrated.

1 found, 7 total

Select entities»

Default: Displacement

Options: Displacement or

Specify from point:

Click the end point as illustrated.

Options: Enter to use from point as displacement or

Specify destination»@100,0

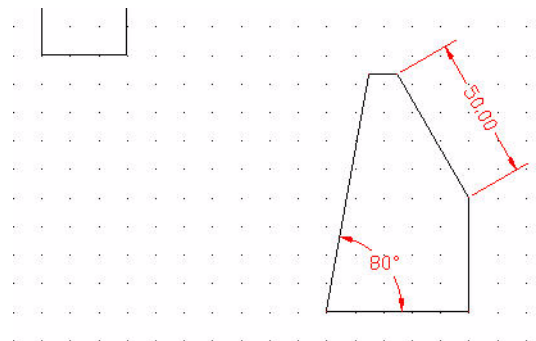
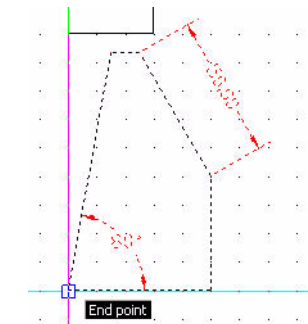
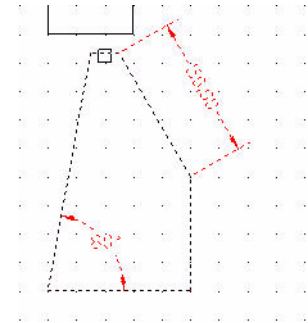

## Coordinate System Command

A coordinate system determines each Point of a drawing surface or entity unambiguously. DraftSight uses the Cartesian coordinate system consisting of three coordinate axes. Axes are arranged orthogonally, crossing at the origin. All axes use the same measurements.

Reset the coordinate system (CCS) from the default position. Use the CCS command to set coordinate systems and save, restore, rename, and delete them.

### Reset the Coordinate System

#### 25 Reset the Coordinate System.

Set the coordinate system position to the bottom left point of the top entity.

Click **Snap** On from the Status bar. The command window displays: <Snap On>.

Click **ESnap** On from the Status bar. The command window displays: <ESnaps On>.

Click **Ortho** On from the Status bar. The command window displays: <Ortho On>.

:

: CCS ↵

Default: World

Options: align to Entity, NAMED, Previous, View, World, X, Y, Z, ZAxis or

Specify origin»

Click the bottom left point as illustrated. View the new coordinate system origin position.

Option: Enter to accept or

Specify X-axis through point» ↵

#### 26 Save the Drawing.

Click the **Save** icon  on the Standard toolbar.

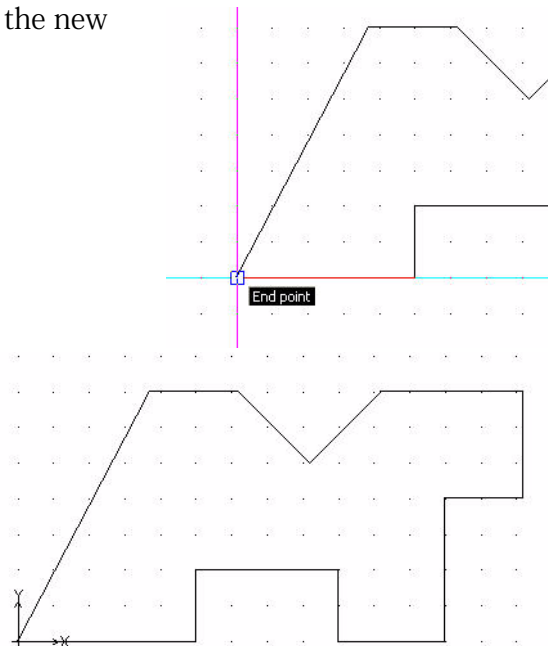

## Ordinate Command

The **Ordinate**  command creates ordinate Point Dimensions. The graphics area displays an X or Y coordinate with a Leader Line to create X datum or Y datum Dimensioning. The value of the X or Y coordinate is defined by the Point you specify, called the feature position.

### Create Ordinate Dimensions

Create Ordinate Dimensions on the top entity using the new origin position.

#### 27 Create Ordinate Dimensions.

Click the **Ordinate** icon  on the Dimension toolbar.

**NOTE:** Make sure that Snap mode is set to OFF. Click **Snap** on the Status bar. The command window will display <Snap Off>

**NOTE:** Make sure that Ortho mode is set to ON. Click **Ortho** on the Status bar. The command window will display <Ortho on>

Specify datum position»

Click the bottom left end point.

options: Angle, Note, Text, X  
datum, Y datum or

Specify dimension position»

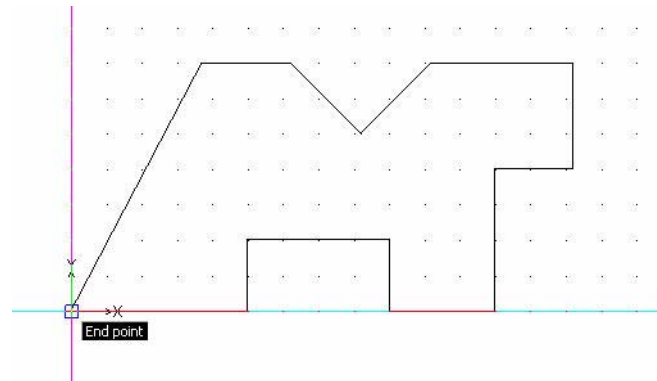

Click a position directly under the end point. The command window displays:

Dimension Text: 0.00

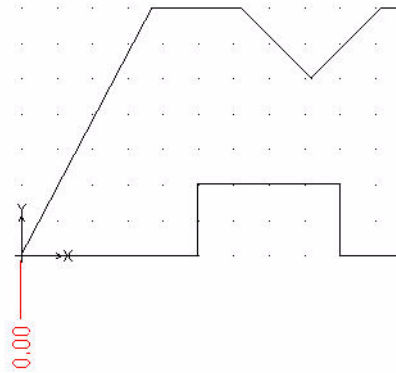

Click the **Continue** icon  on the Dimension toolbar.

Options: Select dimension, Undo or Specify feature position»

Click all the end points from left to right as illustrated.

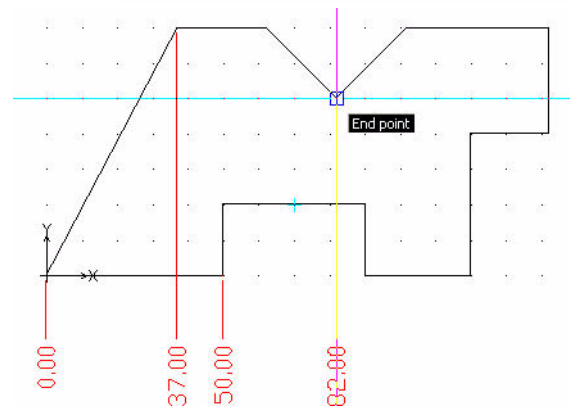

Options: Select dimension, Undo or Specify feature position»  
Specify dimension»

**28 Save the Drawing.**

Click the **Save** icon  on the Standard toolbar.

**CenterMarks Command**

The **CenterMark**  command provides the ability to mark the center of a Circle or Arc. You can display the center as a center mark (a Point) or as a Center Line (a broken Line crossing the center).

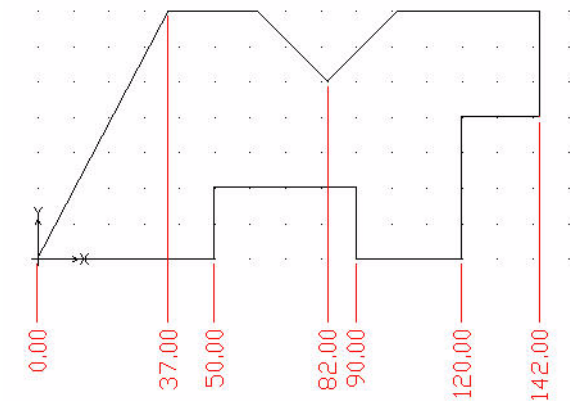



In the next section, open **Lesson 2-2** and create a new layer called Annotations. Insert CenterMarks on the Annotations layer in the drawing.

## Open an Existing Drawing

- 1 Click the **Open** icon  on the Standard toolbar. The **Open** dialog box is displayed.
- 2 Double-click **Lesson 2-2**.

## Create a New Layer

In this section, create a new layer called Annotations.  
Apply custom properties.

- 3 **Create the New Layer.**  
Click the **Layers Manager** icon.  The **Layers Manager** dialog box is displayed.  
  
Click the **New Layer** icon.  The new default name is Layer1.  
Rename this Layer Annotations.

*Annotations* is the new layer name.

- 4 **Set the LineColor.**  
New layers are automatically assigned the LineColor white.  
Double-click the **LineColor** cell for the **Annotations** layer.  
Click **Magenta**.  
Click **OK**.
- 5 **Save the Drawing.**  
Click File, **Save As** from the Menu bar.  
Enter **File name:** Lesson 3-2.  
Click **Save** from the **Save As...** dialog box.

## DimensionStyle Command

The **DimensionStyle**  command on the Dimension toolbar provides the ability to create and modify DimensionStyles. Remember, DimensionStyles are the main method used to control the way Dimensions look.

- 6 **Set DimensionStyle**  
Click the **DimensionStyle** icon  on the Dimension toolbar. The **DimensionStyles Manager** dialog box is displayed.  
  
The **Options - Drafting Styles** dialog box is displayed with the **Dimensions** option expanded.

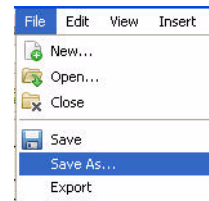
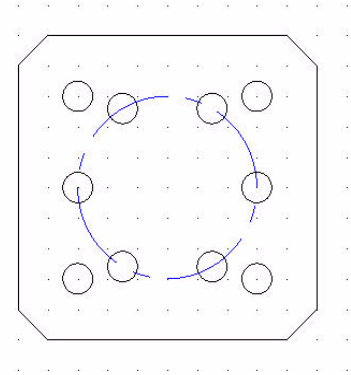

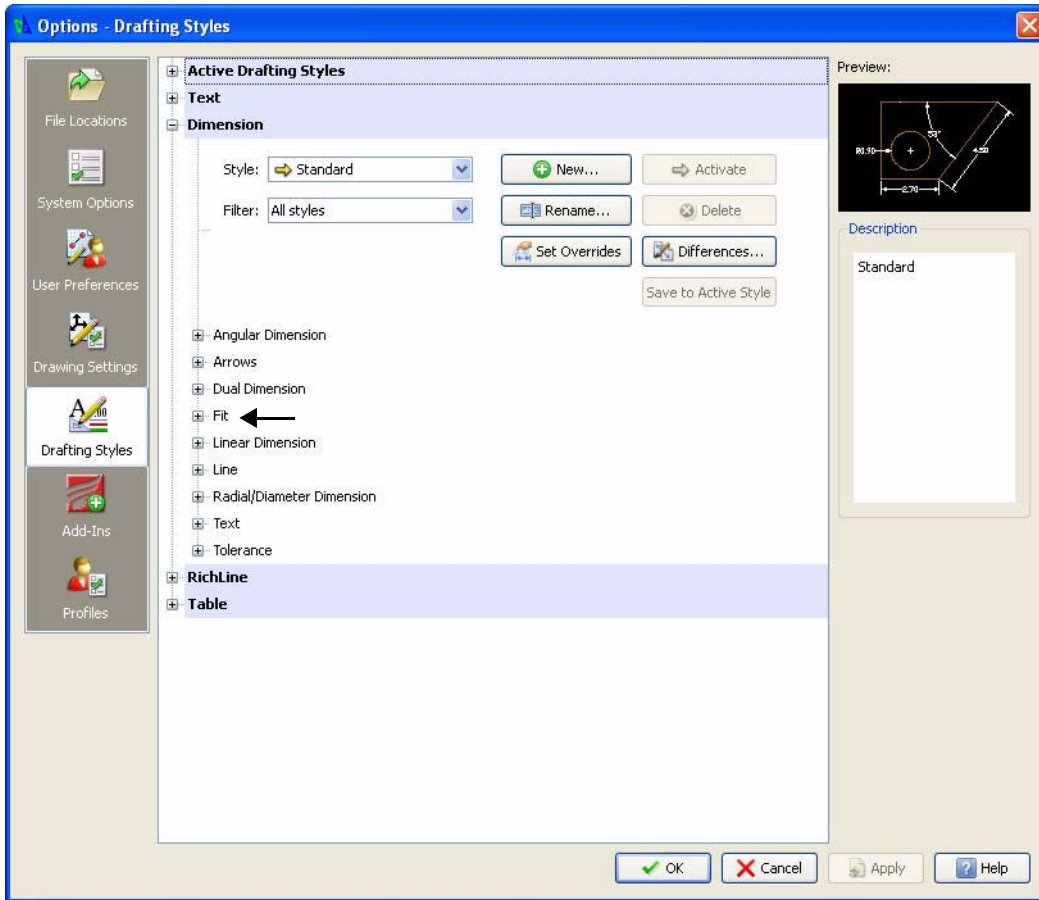

Expand the **Fit, Dimension scale** option.

View the **Fit** options displayed on the right side of the dialog box.

**Scale factor:** Enter 25.

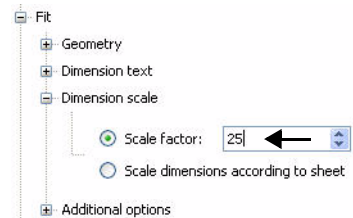

### Modify the Default CenterMark Size

#### 7 Set the Radial Dimension of the CenterMark.

Expand **Radial/Diameter Dimensions, Center mark display** from the **Navigation** box.

Click **As mark** on the dialog.

Enter 2.5 for **Size**.

Click **OK**.

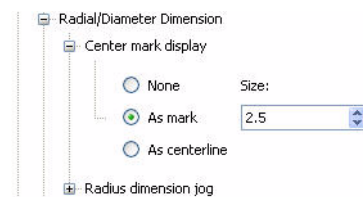

#### 8 Insert CenterMarks.

Click the **CenterMark** icon  on the Draw toolbar.

Specify curved entity»

Click the circumference of the bottom left Circle as illustrated.

: ↵

Specify curved entity»

Click the circumference of the top left Circle.

: ↵

Specify curved entity»

Click the circumference of the top right Circle.

: ↵

Specify curved entity»

Click the circumference of the bottom right Circle.

Specify curved entity»

Four Center Marks are displayed.

### 9 Save the drawing.

Click the **Save** icon  on the Standard toolbar.

## Create a Pattern of CenterMarks

In the next section, create a circular pattern of CenterMarks on the inside Circles of the drawing.

### 10 Create a Pattern of CenterMarks.

Click the **CenterMark** icon  on the Draw toolbar.

Specify curved entity»

Click the circumference of the right most Circle of the bolt pattern as illustrated. The CenterMark is displayed.

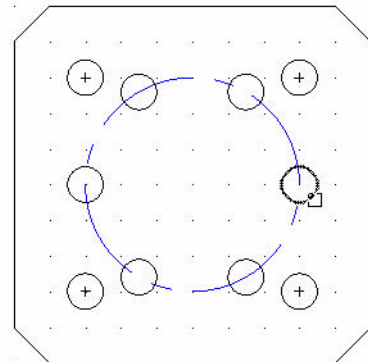
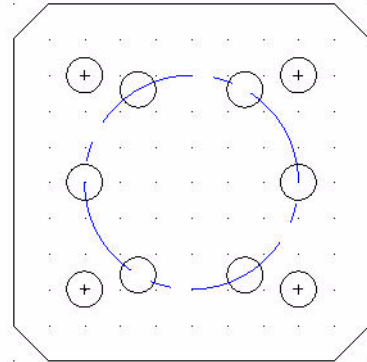
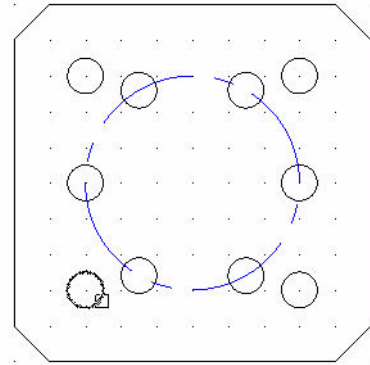

Click the **Pattern** icon  on the Modify toolbar.

The Format Pattern dialog box is displayed. Set the options.

Click the **Circular** button.

Click the **Select Entities** icon.

Select entities»

Click the Horizontal Line of the Center Mark display.

Select entities»

Click the Vertical Line of the Center Mark display.

Select entities»

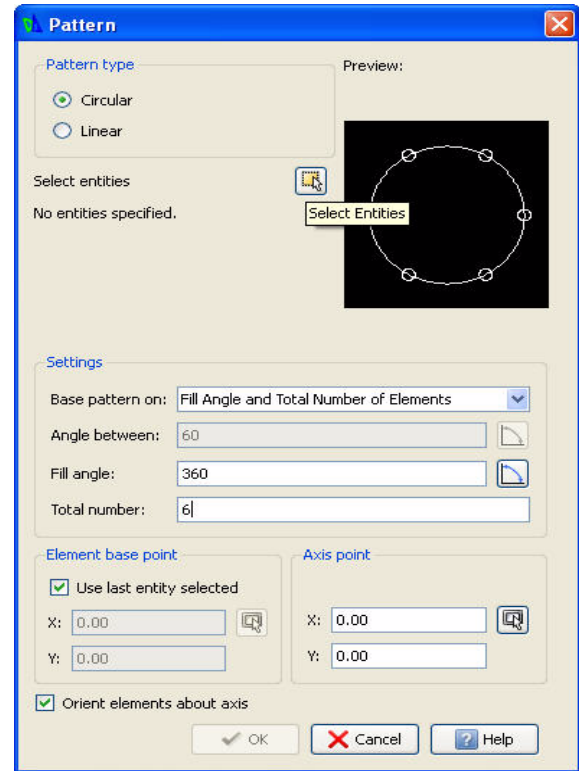

**TIP:** It may be necessary to use the scroll wheel to zoom into the entity.

**Base pattern on:** Fill Angle and total number of Elements

**Fill angle:** Enter 360.

**Total number:** Enter 6.

Click the **Axis Point** icon.  The graphics area is displayed.

Specify pattern center point»

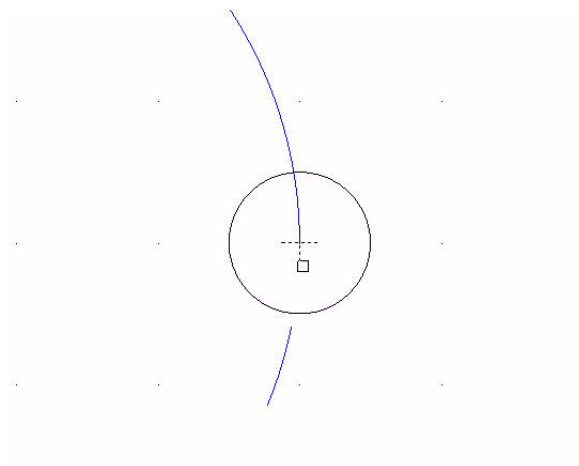



Click the center point of the large Circle as illustrated.  
The **Pattern** dialog box is displayed.

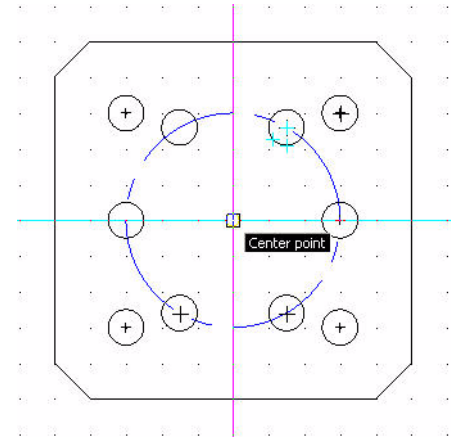

View the **Axis point X: = 100.00** and the **Axis point Y: = 100.00**

The **Orient elements about axis** box is checked by default. This option provides the ability to have the CenterMarks rotate about the large Circle.

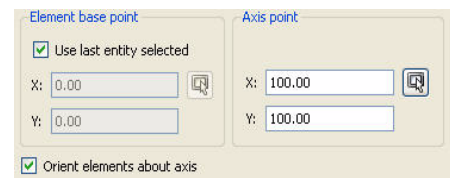

Click **OK**.

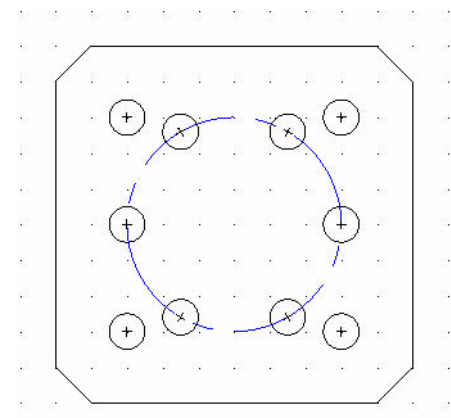

### 11 Activate the Annotations Layer.

Click Annotations from the Layers Manager drop-down menu.

### Radius Command

The **Radius**  command provides the ability to create Radial Dimensions for Circles and Arcs. Radius Dimensioning is carried out in the same way as Diameter Dimensioning, the only difference being that a Radius Dimension is calculated instead of a diameter measurement. Create a Radial Dimension for the large Circle.

### 12 Create a Radius Dimension.

Click the **Radius** icon  on the Dimension toolbar.  
Specify curved entity»

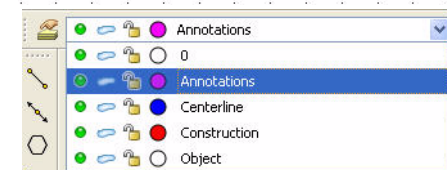

Click the circumference of the large Circle.

Options: Angle, Note, Text or  
 Specify dimension position»

Click a position diagonally to the right.

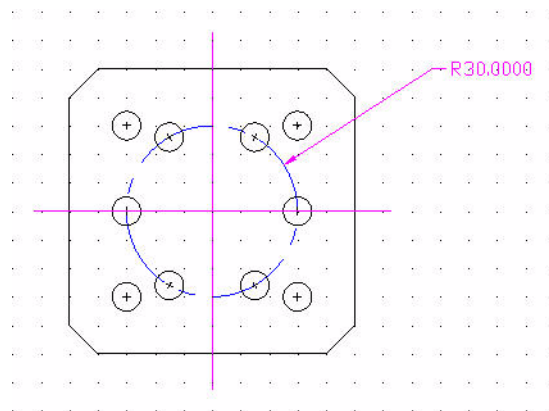

**NOTE:** The dimension text = 30.0000.

**13 Save the Drawing.**

Click the **Save** icon  on the Standard toolbar.

**14 Modify the Precision.**

Click the **DimensionStyle** icon  on the Dimension toolbar.

The **Options - Drafting Styles** dialog box is displayed with the **Dimensions** option expanded.

Expand **Linear Dimension** in the **navigation** box.

View the Linear Dimensions options displayed on the right side of the dialog box.

**Precision:** Select **0.00** from the drop-down menu.

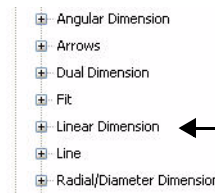

Click **OK**.

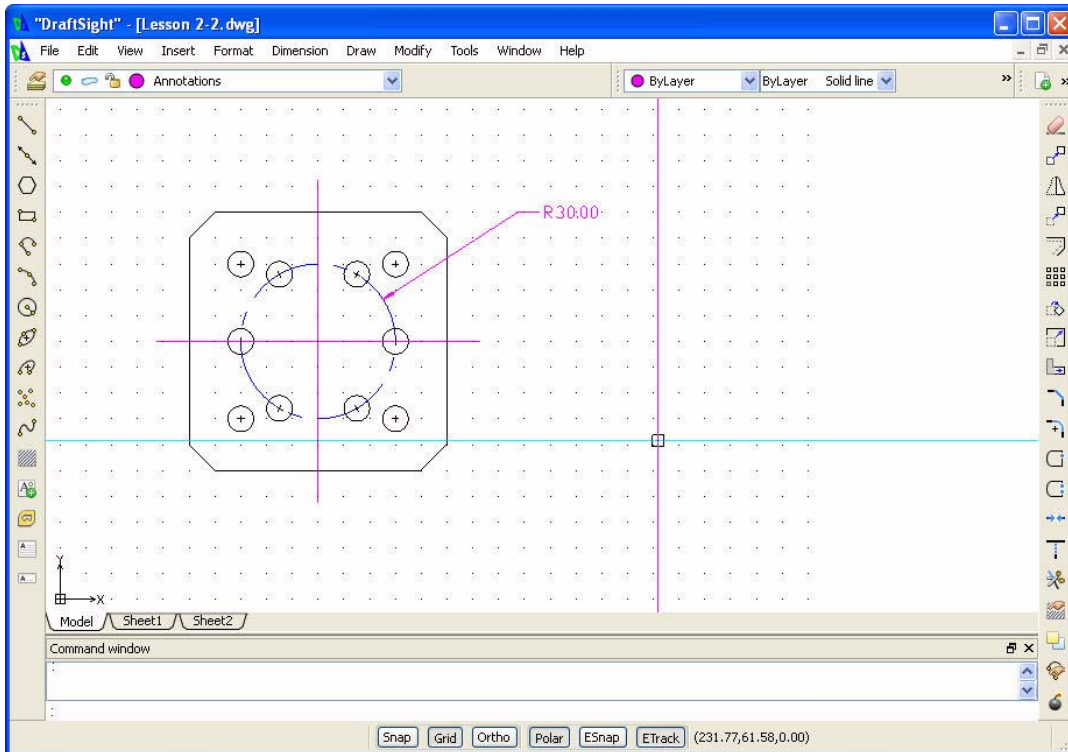

### 15 Save the Drawing.

Click the **Save** icon  on the Standard toolbar.

You are finished with this section.



## Lesson 4 DRAFTING APPLICATION

When you complete this lesson, you will be able to:







Apply the MakeBlock, Note, and Line Draw commands

- Make and Insert Blocks
- Create and Edit a Note
- Apply the Ring command
- Explode a Block
- Apply the Hatch/Fill command
- Create a Multiview drawing
- Apply a Tolerance

## Drafting Application

During this lesson, you will create two new drawings using absolute coordinates in the Command prompt and the graphics area.

In the first drawing you will:

- Create two new layers with custom properties: Symbols and Schematic.
- Activate the Symbols layer.
- Use the **Line**  command to draw the entities.
- Apply the **Note**  command.
- Create a single entity with the **MakeBlock**  command.
- Use the **Insert Block** dialog box.
- Apply the **Insert Block**  command to insert two Symbol copies.
- Use the **Insert Block** dialog box.
- Activate the Schematic layer.
- Use the **Line**  command to draw two Horizontal Parallel Lines between the top symbols on the Schematic layer.
- Activate the Symbols layer. Apply the **Line**  command to draw three Horizontal and Parallel Lines: 30, 20, and 10mm's in length and 5mm's apart. Draw a Vertical Line perpendicular at the mid point to the top Horizontal Line 20mms in length.

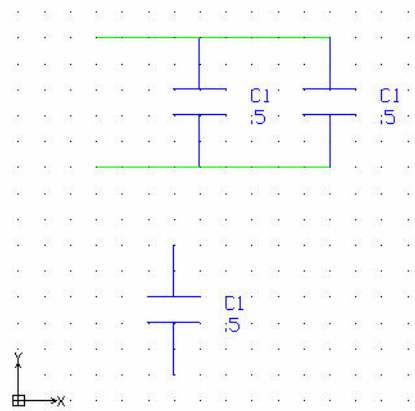
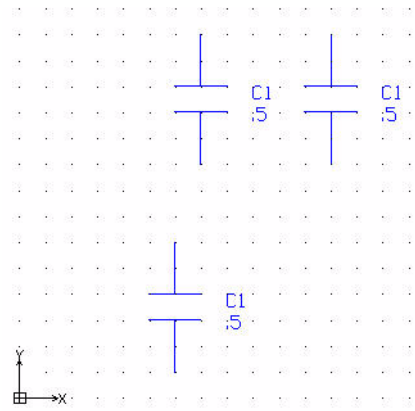

- Create a single entity with the **MakeBlock**  command.

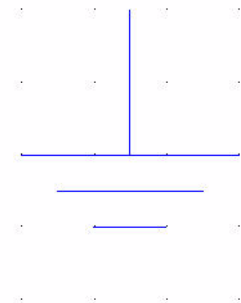

- Use the **Define Block** dialog box.
- Apply the **InsertBlock**  command to insert the Symbol (Ground).
- Use the **Insert Block** dialog box.

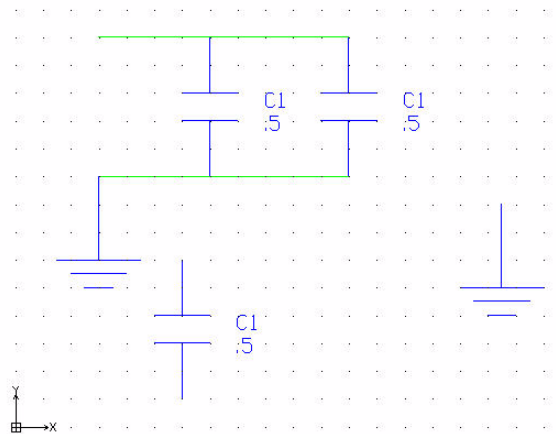

- Apply the **Ring** command to create a ring with an inside diameter of **0mm**, and outside diameter of **2mm**.
- Apply the **Explode**  command. The Explode command provides the ability to explode a symbol into its component entities.
- Edit the Note. Use the **Edit Note** dialog box.

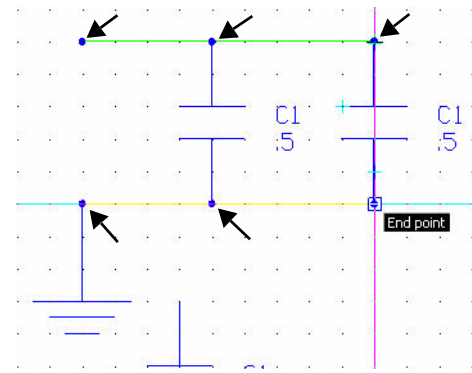
**NOTE:**

A symbol loses its characteristics when exploded, and only a uniform scaled symbol can be exploded.

In the second drawing you will:

- Create six new layers called: Dimensions, Profile, Construction, Center, Hidden, and Section.
- Apply custom properties.
- Draw six Horizontal InfiniteLines and seven Vertical InfiniteLines.
- Draw three profiles.
- Utilize the Line command
- Draw the first profile.

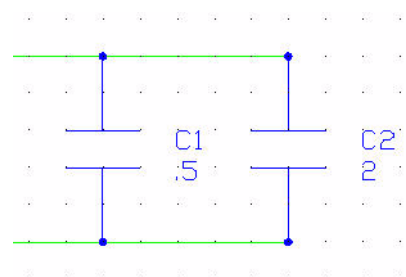
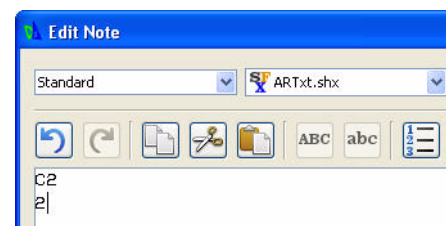

- Draw the second profile.

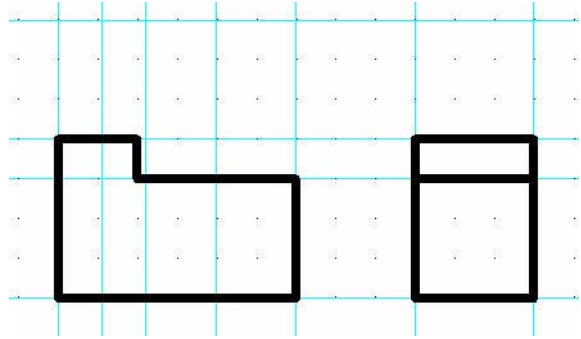

- Draw the third profile.

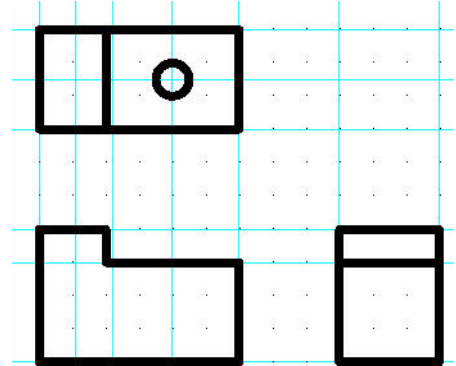

- Draw two Hidden Lines views.

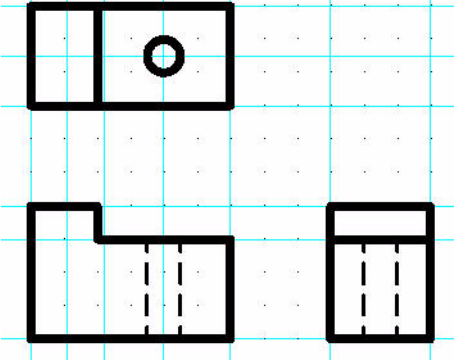

- Apply the Hatch/Fill command.

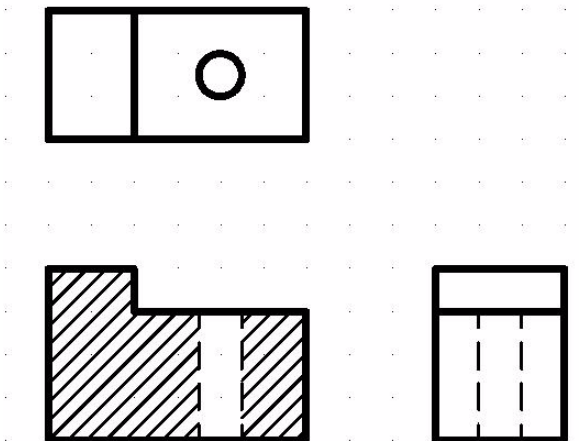



- Apply the **DimensionStyle**  command and dimension the views.

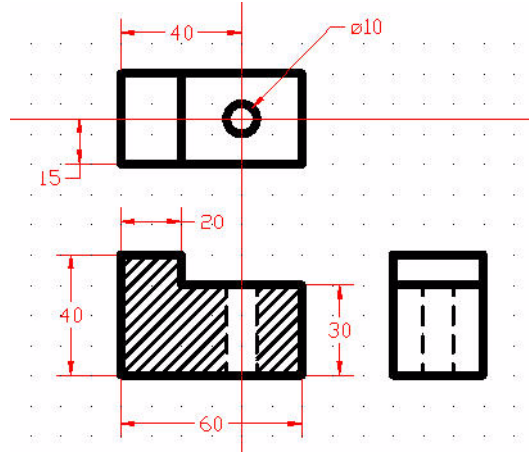

- Apply a Tolerance to the diameter dimension to complete the drawing.

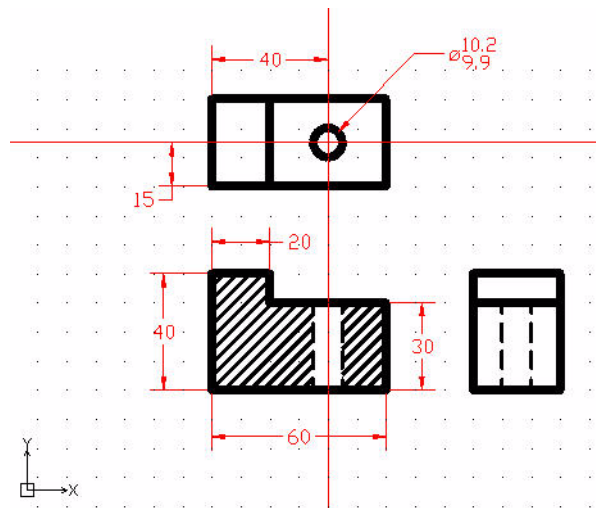

## Start a DraftSight Session

### 1 Start a DraftSight session.

From the Windows Start menu, click **Start, All Programs, Dassault Systemes, DraftSight**.

## Create a New Drawing

### 2 Create a New Drawing.

Click the **New** icon  on the Standard toolbar. The **Select Template** dialog box is displayed.

## Set the Drawing Environment

### Drawing Template

### 3 Select a Default Drawing Template.

Select **standard.dwt** from the **Specify Template** dialog box.

### 4 Click Open.

**TIP:** Double-clicking on the template name will also open the file.

### Drawing Unit System

The default units system is the Decimal system and can be applied to either English (inches) or metric values (millimeters).

#### 5 Set Linear Length Precision.

Click **Format, Unit System...** from the Main Menu.

The **Unit System** section of the **Options - Drawing Settings** dialog box is displayed.

Select **0.00** for **Length Precision**.

#### 6 Set Linear Units Scale.

The **Unit System** section of the **Options - Drawing Settings** dialog box allows you to set the linear and angular unit formats.

Click **Millimeters** for **Block units format** in the **Units scale** section of the dialog box.

Click **OK**.

### Drawing Boundary

Use a horizontal A4 default drawing sheet.

#### 7 Set Drawing Boundary.

Click **Format, Drawing Boundary** from the Main Menu.

Default: (0.00, 0.00)

Options: Off, ON or

Specify lower left corner»↓

Default: (12.00, 9.00)

Specify upper right corner» **297,210**↓

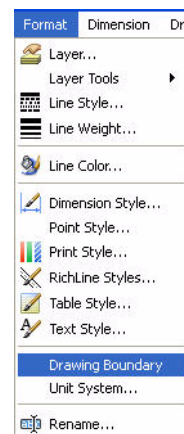

### Set Snap and Grid

Set the **Snap** to **5mms**. Set the **Grid** to **10mms**.

#### 8 Set Snap and Grid.

Click **Tools, Options** from the Main Menu.

The **Options** dialog box is displayed.

Click the **User Preferences** tab.

Expand **Drafting Options, Pointer Control** and **Snap Settings**.

Click the **Enable Snap <F9>** box.

Enter the value of **5** in the **Horizontal Snap spacing** box.  
Press the Tab key The **Vertical Snap spacing** box is updated.

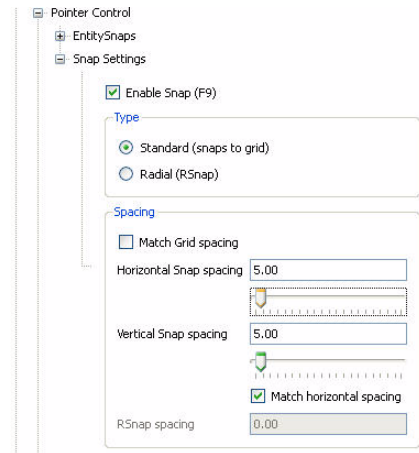

Expand the **Display, Grid Settings** option

Click the **Enable Grid <F7>** box.

Enter **10** in the **Horizontal display spacing** box. Press the **Tab** key. The **Vertical display spacing** box is updated.

Click **OK**.

**9 Display the Drawing with the New Boundary.**

**10 Click View, Zoom, Bounds**  **on the Main Menu.**

**11 Save the Drawing.**

Click the **Save** icon  on the Standard toolbar.

**Enter** File name: Lesson 4-1.

Click **Save**.

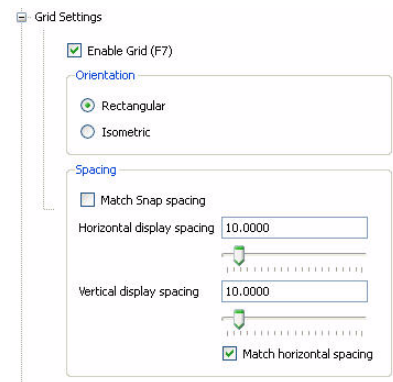

## Create two new Layers for the drawing

In this section, create two new layers called: Symbols and Schematic. Apply custom properties.

**12 Create the First New Layer.**

Click the **Layers Manager** icon  on the Layers toolbar

The **Layers Manager** dialog box is displayed.

Click the **New Layer** icon.  The new default name is Layer1.

Rename this layer **Symbols**

**13 Set the LineColor.**

New layers are automatically assigned the LineColor white.

Double-click the **LineColor** cell for the Symbols layer.

Click **Blue**.

Accept the default LineStyle: Continuous and options.

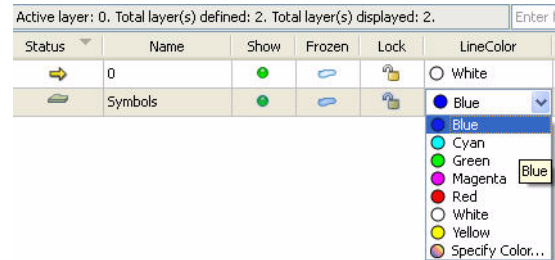

**14 Create the Second New Layer.**

Click the **New Layer** icon. The new default name is Layer2.

Rename this Layer **Schematic**.

*Schematic* is the new layer name.

**15 Set the LineColor.**

Double-click the **LineColor** cell for the Schematic layer.

Click **Green**.

Accept the default LineStyle: Continuous.



**16 Activate the Symbols Layer.**

Click inside the **Status** cell of the Symbols layer.

Click the **Activate Layer** icon. A gold arrow is displayed in the Symbols **Status** cell.

Click **OK**.

**Draw a capacitor symbol**

Draw multiple entities on the Symbols layer. Apply the **Line** icon, and **Note** icon commands. Use the **Edit Note** dialog box to create a note with a **5mm** height, left justify to the right of the drawing.

Create a single entity with the **MakeSymbol** icon command. Use the **Define Symbol** dialog box. Apply the **Insert, Symbol** icon command from the Main Menu to insert two Symbol copies. Use the **Insert Symbol** dialog box.

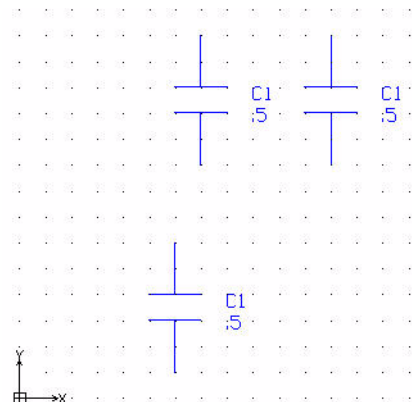

**17 Apply the Line Command.**

Draw two Horizontal Parallel Lines 20mms long and 10mms apart.

Click the **Line** icon on the Draw toolbar.

Options: Segments, or  
Specify start point>>**50,30**↵

Options: Segments, Undo, *Enter to exit* or  
Specify next point>>**70,30**↵  
↵

Options: Segments, *Enter to continue from last point* or

Specify start point >> **70,40** ↵

Options: Segments, Undo, *Enter to exit* or

Specify next point >> **50,40** ↵

Right-click **Enter**.

Draw two Vertical Lines perpendicular to the midpoint of the two Horizontal Lines.

: ↵

Options: Segments, *Enter to continue from last point* or

Specify start point >> **60,30** ↵

Options: Segments, Undo, *Enter to exit* or

Specify next point >> **60,10** ↵

Right-click **Enter**.

: ↵

Options: Segments, *Enter to continue from last point* or

Specify start point >> **60,40** ↵

Options: Segments, Undo, *Enter to exit* or

Specify next point >> **60,60** ↵

Right-click **Enter**.

## 18 Save the Drawing.

Click the **Save** icon  on the Standard toolbar.

### Note Command

The **Note**  command provides the ability to enter multiple Lines of text that are treated as a single entity. In the next section, use the **Edit Note** dialog box to create a note with a 5mm height, left justify to the right of the drawing.

## 19 Create a Note.

Click the **Note** icon  on the Draw toolbar.

Active TextStyle: "Standard" Text height: 0.20

Specify first corner >> **80,40** ↵

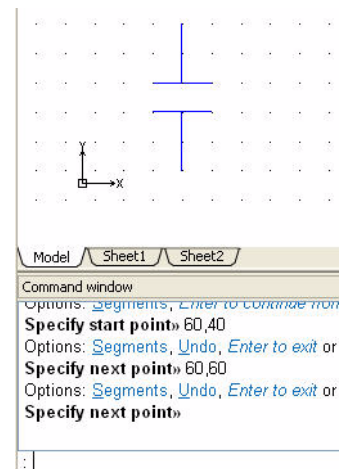

Options: Angle, Height, Justify, Line spacing, textStyl e, Width or  
Specify opposite corner>> h.↓

default: 0.20

Specify text height>>5.↓

Options: Angle, Height, Justify, Line spacing, textStyl e, Width or  
Specify opposite corner>>100, 20.↓

The **Edit Note** dialog box is displayed.

Enter **C1**.

Press the **Enter** key.

Enter **.5**

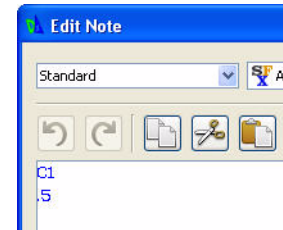

Click **OK** from the **Edit Note** dialog box.



Return to the graphics area.

## 20 Save the Drawing.

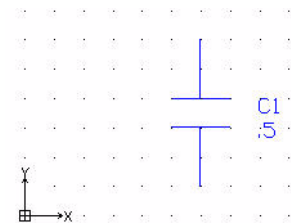
Click the **Save** icon  on the Standard toolbar.



## Blocks

A Block is a collection of entities bound together as a single entity. After you create a Block, you can insert it whenever you need it in a drawing. When you use the **MakeBlock**  command, the symbol is recognized in the current drawing only. The **MakeBlock**  command lets you write a symbol to an external drawing file for use in any drawing. In the next section, create a Block named Capacitor.

## 21 Apply the MakeBlock Command.

Create a symbol named Capacitor.

Click the **MakeBlock** icon  on the Draw toolbar.

The **Block Definition** dialog box is displayed.

**Name:** Enter **Capacitor**.

**Description:** Enter **Vertical Capacitor**.

**Units:** Select **Millimeters**.

**Block entities:** Click the **Select in graphics area**  icon.

Specify entities>>

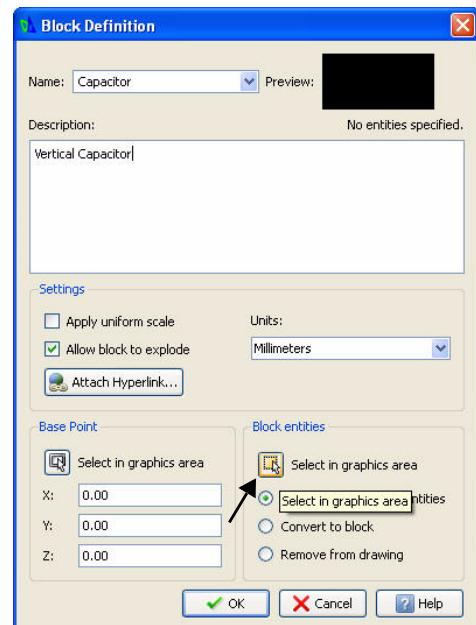

Window-select the capacitor geometry and the note.

**NOTE:** Specify entities: 5 found, 5 total is displayed in the command window.

Specify entities>>↓

The **Block Definition** dialog box is displayed. 5 entities specified is displayed.

**Base Point:** Click the **Select in graphics area** icon.

Specify insertion base point>>

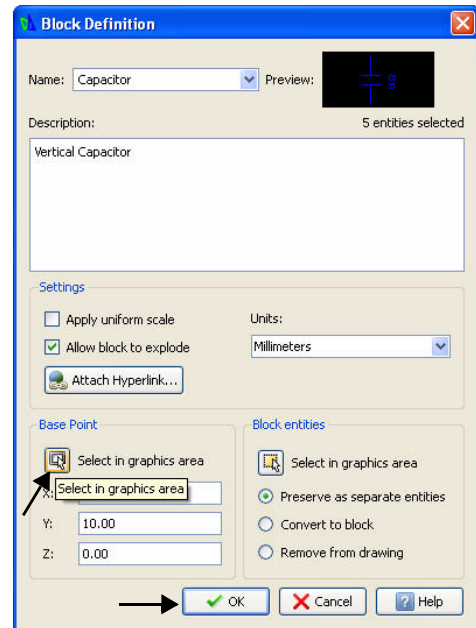

Click the bottom endpoint of the Vertical Line as illustrated.

The **Block Definition** dialog box is displayed.

Click **OK**.

## 22 Insert the Block.

Insert the Capacitor symbol twice above the original symbol.

Click **Insert, Block**  from the Main menu.

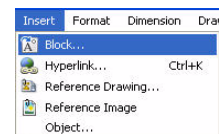
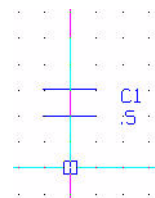

The **Insert Block** dialog box is displayed. The **Insert Block** dialog box provides the ability to select created symbols. Capacitor is selected by default.

**Position X:** Enter **70**.

**Position Y:** Enter **90**.

Click **OK**.

: ↵

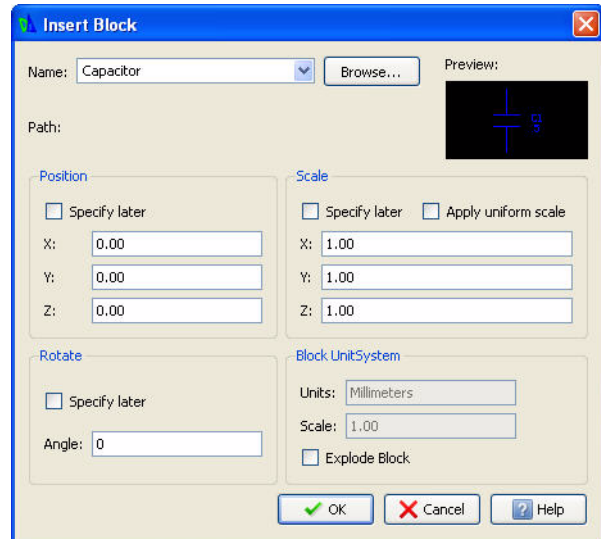

The **Insert Block** dialog box is displayed. Capacitor is selected by default.

**Position X:** Enter **120**.

**Position Y:** Enter **90**.

Click **OK**.

### 23 Save the Drawing.

Click the **Save** icon  on the Standard toolbar.

## Draw a Simple Schematic

### 24 Activate the Schematic Layer.

Click **Schematic** from the drop-down menu in the **Layers Manager**. Schematic is the active layer.

### 25 Apply the Line Command.

Draw two Horizontal Parallel Lines between the top symbols on the Schematic layer.

Click the **Line** icon  on the Draw toolbar.

Click **Snap** from the Status bar. The command window displays: <Snap Off>.

Options: Segments, *Enter to continue from last point* or *Specify start point*>>

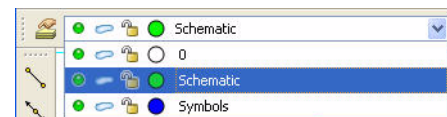
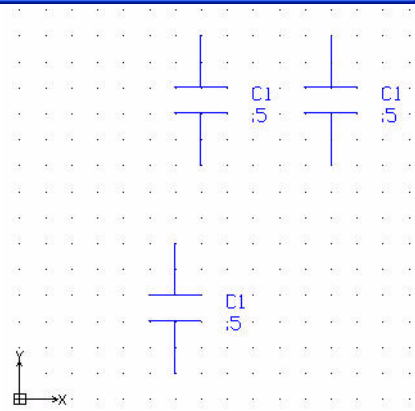



Click the top end point of the symbol to the right.

Options: Segments, Undo or Enter to exit or Specify next point>>

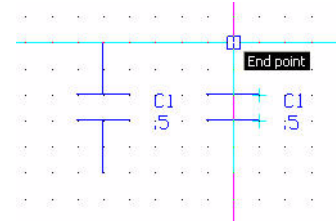

Click a Point directly to the left as illustrated.

Options: Segments, Undo or Enter to exit or Specify next point>>↵

: ↵

Options: Segments, Enter to continue from last point or Specify start point>>

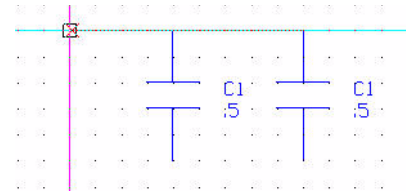

Click the bottom end point of the symbol to the right.

Options: Segments, Undo or Enter to exit or Specify next point>>

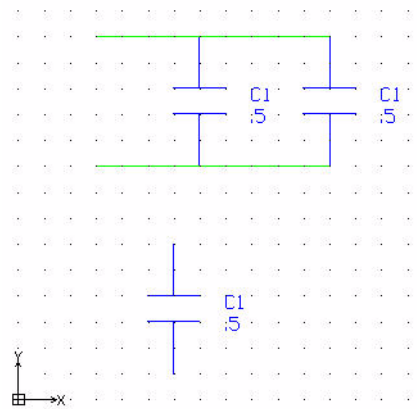

Click a Point directly to the left as illustrated.

Options: Segments, Undo or Enter to exit or Specify next point>>↵



## 26 Draw a Ground Symbol

Apply the **Line**  command to draw three Horizontal and Parallel Lines: 30, 20, and 10mms in length and 5mm's apart. Draw a Vertical Line perpendicular at the midpoint to the top Horizontal Line 20mms in length.

Create a single entity (Ground symbol) with the **MakeBlock**  command. Use the **Define Block** dialog box. Apply the **Insert, Block**  command to insert the Block (Ground symbol). Use the **Insert Block** dialog box.

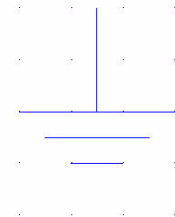

## 27 Activate the Symbols Layer.

Click **Symbols** from the drop-down menu in the **Layers Manager**. Symbols is the active layer.

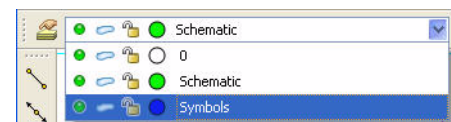

## 28 Apply the Line Command.

Click the **Line** icon  on the Draw toolbar.

Draw the first Horizontal Line.

Options: Segments, Enter to continue from last point or Specify start point>>160,50↵

Options: Segments, Undo or  
 Specify next point>>**190,50**↵  
 Right-click **Enter**.

Draw the second Horizontal Line.  
 :↵

Options: Segments, *Enter to continue from last point* or  
 Specify start point>>**165,45**↵

Options: Segments, Undo or  
 Specify next point>>**185,45**↵  
 Right-click **Enter**.

Draw the third Horizontal Line.  
 :↵

Options: Segments, *Enter to continue from last point* or  
 Specify start point>>**170,40**↵

Options: Segments, Undo or  
 Specify next point>>**180,40**↵  
 Right-click **Enter**.

Draw the Vertical Line.  
 :↵

Options: Segments, *Enter to continue from last point* or  
 Specify start point>>

Click the **midpoint** of the 30mm Horizontal Line.

Options: Segments, Undo or  
 Specify next point>>**@0,30**↵

Right-click **Enter**.

In the next section you will create a symbol called Ground.

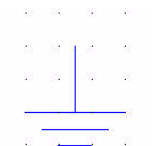
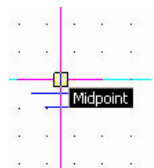

**29 Apply the MakeBlock Command.**

Create a symbol named Ground on the Symbols layer.

Click the **MakeBlock** icon  on the Draw toolbar. The **Block definition** dialog box is displayed.

**Name:** Enter **Ground**.

**Description:** Enter **Ground Symbol**.

**Units:** Select **Millimeters**.

**Block entities:** Click the **Select in graphics area**  icon.

Specify entities >>

Window-select the three horizontal and single Vertical Lines.

Specify entities >>> ↵

The **Define Symbol** dialog box is displayed. 4 entities specified is displayed.

**Base Point:** Click the **Select in graphics area**  icon.

Specify insertion base point >>

Click the top end point of the Vertical Line as illustrated.

The **Block Definition** dialog box is displayed.

Click **OK**.

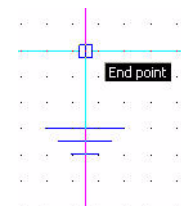
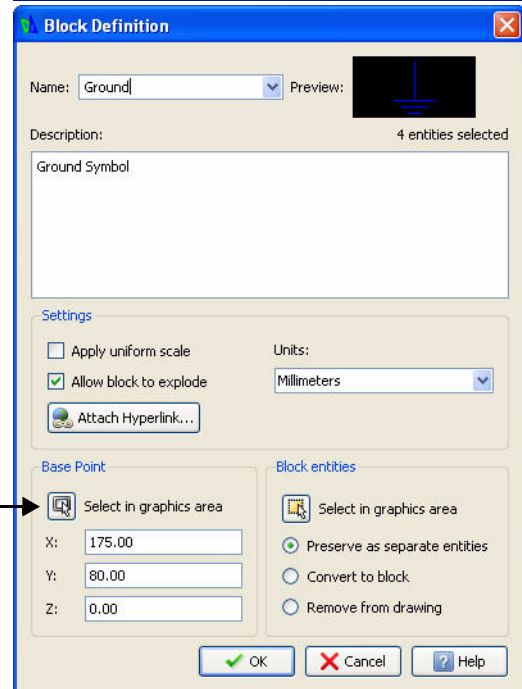
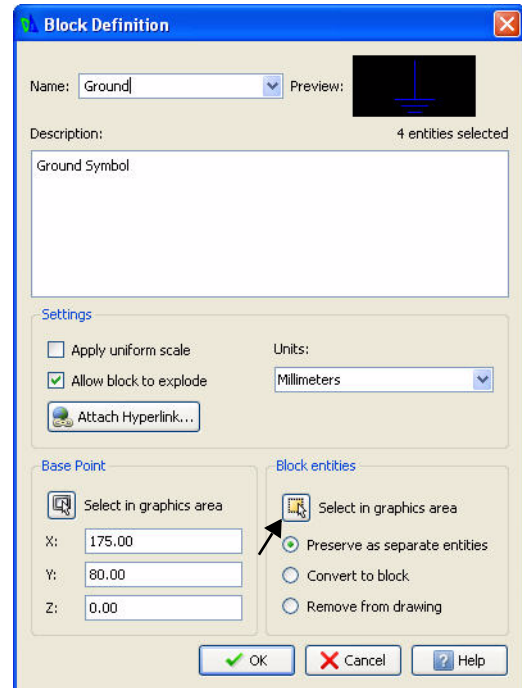

**30 Insert the Block.**

Insert the Ground symbol.

Click **Insert, Block**  from the Main Menu. The **Insert Block** dialog box is displayed.

The **Insert Block** dialog box provides the ability to select created symbols.

Ground is selected by default.

**Position X:** Enter **30**.

**Position Y:** Enter **90**.

Click **OK**.

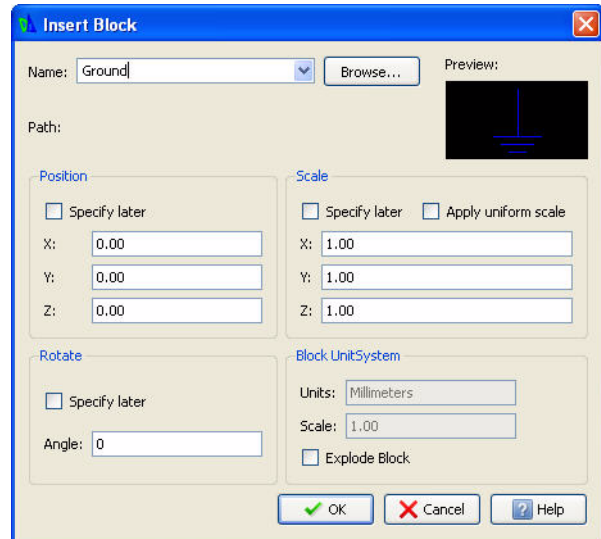
**31 Save the Drawing.**

Click the **Save** icon  on the Standard toolbar.

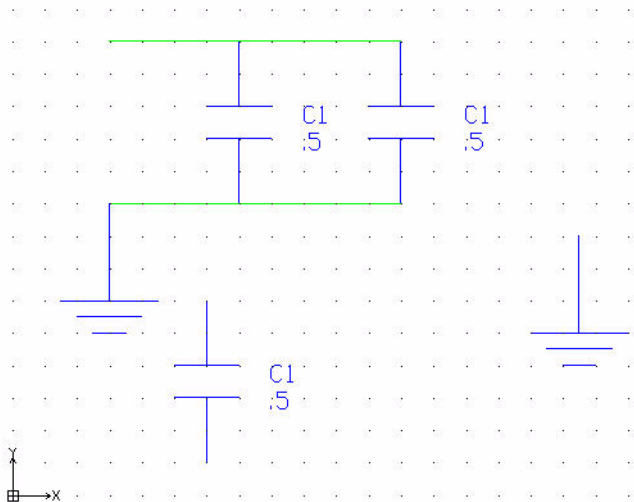
**Ring Command**

The **Ring** command provides the ability to construct a ring of any thickness or size by specifying the diameters of two concentric Circles. The area between the Circles is filled. A filled Circle has an inner diameter of zero. Apply the Ring command in the next section. Create a **ring** with an inside diameter of **0**, and outside diameter of **2mms**.

**32 Apply the Ring Command.**

: Ring ↵

Default t: 0.50

Specify inside diameter >> 0 ↵

Default t: 1.00

Specify outside diameter >> 2 ↵

Default: exit

Specify position>>

Click the six endpoints as illustrated in the graphics area.

Default: exit

Specify position>>↵

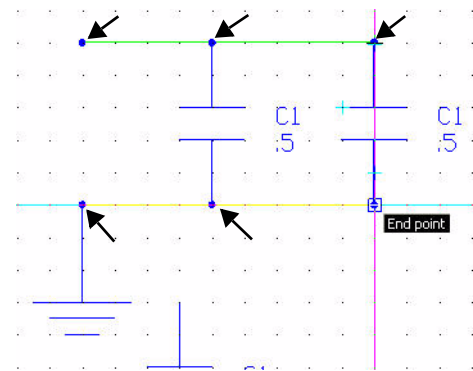

### Explode a Block

DraftSight provides the ability to explode a Block into its component entities. A Block loses its characteristics when exploded, and only a uniform scaled Block can be exploded.

#### NOTE:

You can explode complex entities like PolyLines, Hatches and Dimensions.

### 33 Explode a Block.

Click the **Explode** icon  on the Modify toolbar.

Specify entities>>

Click the **Block** as illustrated in the graphics area. Remember, a symbol is a single entity

1 found, 1 total

Specify entities>>↵

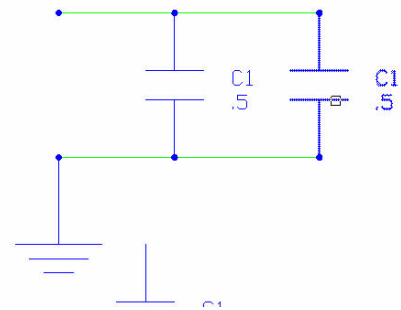

You can now select the individual Line entities and note.

Press **Esc** or **Enter** to exit.

### 34 Save the Drawing.

Click the **Save** icon  on the Standard toolbar.

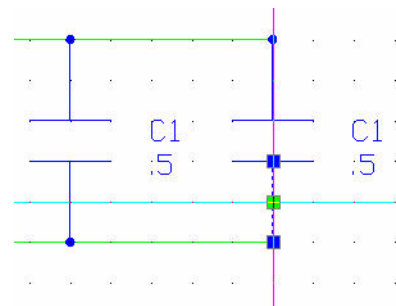

**35 Edit the Note in the Exploded Symbol.**

Double-click the **C1 .5** text in the exploded symbol.

The **Edit Note** dialog box is displayed.

Delete **C1** and **.5** in the text box.

Enter **C2** in the text box.

Press the Enter key.

Enter **2** in the text box.

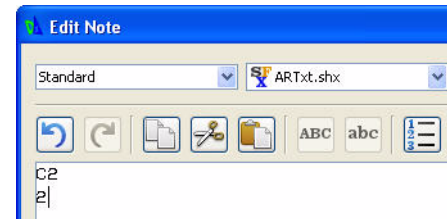
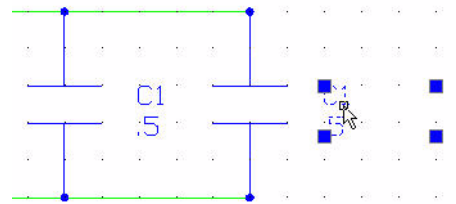

Click **OK**.

View the results in the graphics area.

**36 Save the Drawing.**

Click the **Save** icon  on the Standard toolbar.

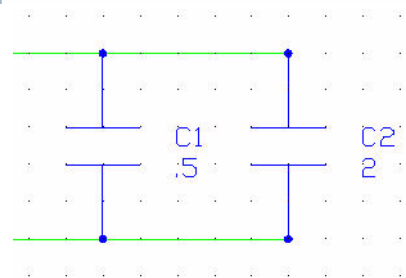
**TIP:**

Visit [www.3DContentCentral.com](http://www.3DContentCentral.com)!

3D ContentCentral is a service for locating, configuring, downloading, and requesting 3D parts and assemblies, 2D Blocks, library features, and macros. Join an active community of thousands CAD users who share and download user contributed and supplier-certified 3D parts & assemblies, 2D Blocks, library features and macros.

## Create a New Drawing

**1 Create a New Drawing.**

Click the **New** icon  on the Standard toolbar. The **Select Template** dialog box is displayed.

## Set the Drawing Environment

### Drawing Template

**2 Select a Default Drawing Template.**

Select **standard.dwt** from the **Specify Template** dialog box.

**3 Click Open.**

## Drawing Unit System

The default units system is the Decimal system and can be applied to either English (inches) or metric values (millimeters).

### 4 Set Linear Length Precision.

Click **Format, Unit System...** from the Main Menu.

The **Unit System** section of the **Options - Drawing Settings** dialog box is displayed.

Select **0.00** for **Length Precision**.

### 5 Set Linear Units Scale.

The **Unit System** section of the **Options - Drawing Settings** dialog box allows you to set the linear and angular unit formats.

Click **Millimeters** for **Block units format** in the **Units scale** section of the dialog box.

Click **OK**.

## Drawing Boundary

Use a horizontal A4 default drawing sheet.

### 6 Set Drawing Boundary.

Click **Format, Drawing Boundary** from the Main Menu.

Default: (0.00, 0.00)

Options: OFF, ON or

Specify lower left corner»↵

Default: (12.00, 9.00)

Specify upper right corner» **297,210**↵

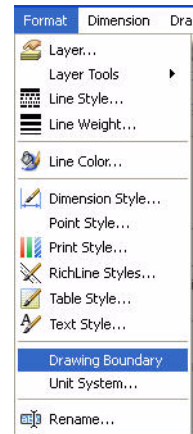

## Set Snap and Grid

Set the **Snap** to **5mms**. Set the **Grid** to **10mms**.

### 7 Set Snap and Grid.

Click **Tools, Options** from the Main Menu.

The **Options** dialog box is displayed.

Click the **User Preferences** tab.

Expand **Drafting Options, Pointer Control** and **Snap Settings**.

Click the **Enable Snap <F9>** box.

Enter the value of **5** in the **Horizontal Snap spacing** box.

Press the Tab key The **Vertical Snap spacing** box is updated.

Expand the **Display, Grid Settings** option

Click the **Enable Grid <F7>** box.

Enter **10** in the **Horizontal display spacing** box. Press the Tab key. The **Vertical display spacing** box is updated.

Click **OK**.

- 8 Display the Drawing with the New Boundary.
- 9 Click View, Zoom, Bounds  on the Main Menu.
- 10 Save the Drawing.

Click the **Save** icon  on the Standard toolbar.

Enter File name: Lesson 4-2.

Click **Save**.

### Create Six New Layers

In this section, create six new layers called: Dimensions, Object, Construction, Center, Hidden, and Section. Apply custom properties.

- 11 Create Six New Layers.

Click the **Layers Manager** icon  on the Layers toolbar.

The **Layers Manager** dialog box is displayed. Create the layers as illustrated with custom properties.

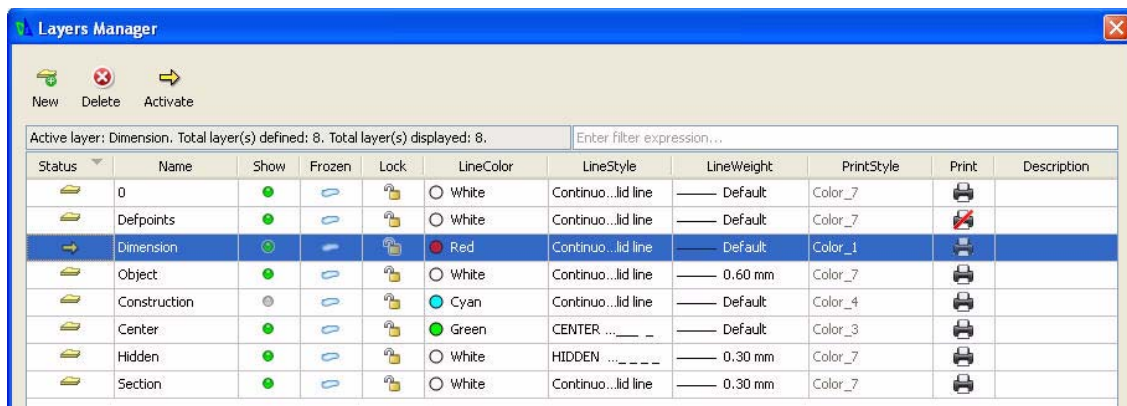

T

**NOTE:** The LineWeight has been changed for the Object, Hidded and Section Layers.

- 12 Activate the Construction Layer.

Click inside the **Status** cell of the Construction layer.

Click the **Activate Layer** icon. A gold arrow is displayed in the Construction **Status** cell.

Click **OK**.

- 13 Draw Six Horizontal InfiniteLines

Click the **Infinite Line** icon  on the Draw toolbar.

Options: Angle, angle Bisect, Horizontal, Offset, Vertical, Enter to exit or

Specify position»H.┘



Options: *Enter to exit* or  
Specify next point»100,100.↓

Options: *Enter to exit* or  
Specify next point»100,130.↓

Options: *Enter to exit* or  
Specify next point»100,140.↓

Options: *Enter to exit* or  
Specify next point»100,170.↓

Options: *Enter to exit* or  
Specify next point»100,185.↓

Options: *Enter to exit* or  
Specify next point»100,200.↓

Options: *Enter to exit* or  
Specify next point»↓

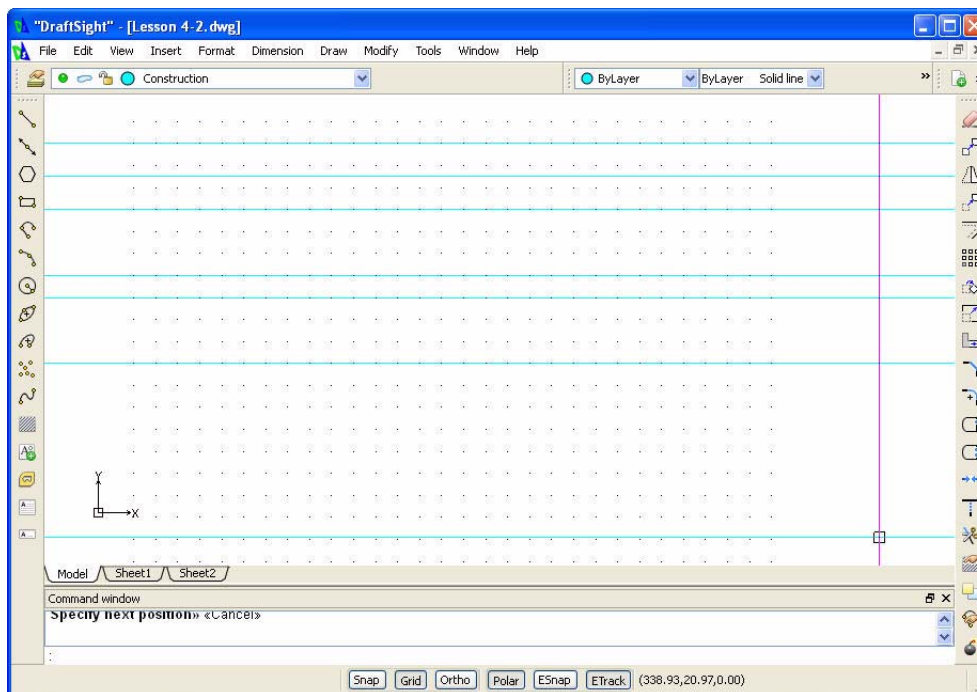

**14 Draw Seven Vertical InfiniteLines**

Click the **Infinite Line** icon  on the Draw toolbar.

Options: Angle, angle Bisect, Horizontal, Offset, Vertical, *Enter to exit* or

Specify position»V↵

Options: *Enter to exit* or

Specify next point»100,100↵

Options: *Enter to exit* or

Specify next point»110,100↵

Options: *Enter to exit* or

Specify next point»120,100↵

Options: *Enter to exit* or

Specify next point»140,100↵

Options: *Enter to exit* or

Specify next point»160,100↵

Options: *Enter to exit* or

Specify next point»190,100↵

Options: *Enter to exit* or

Specify next point»220,100↵

Options: *Enter to exit* or

Specify next point»↵

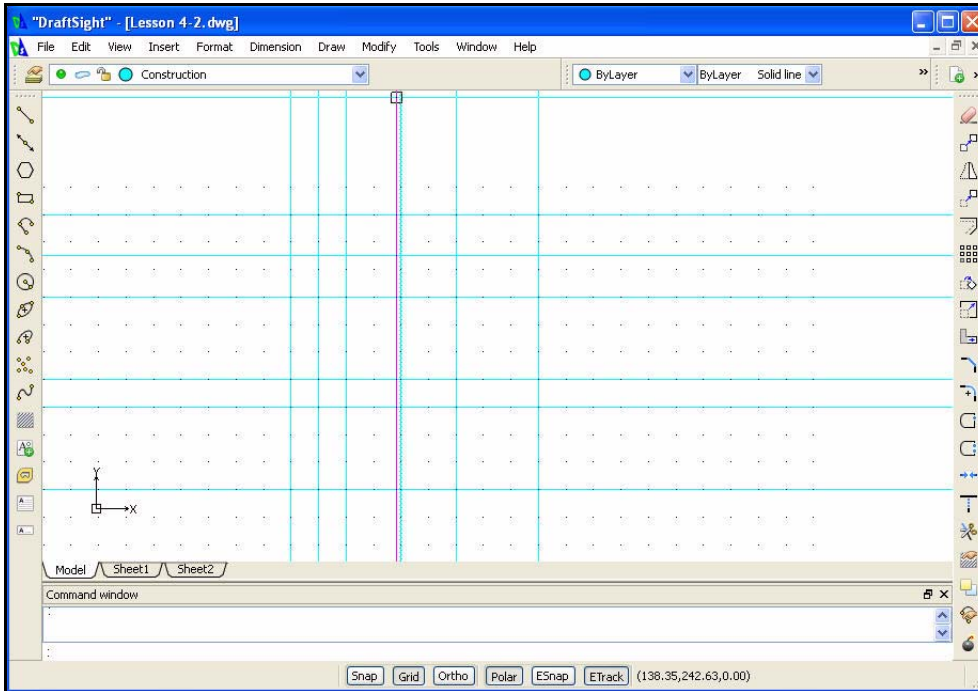

- 15 Activate the Object Layer and Display the LineWeight.**  
Click **Object** from the drop-down menu in the **Layers Manager**.

Object is the active layer.

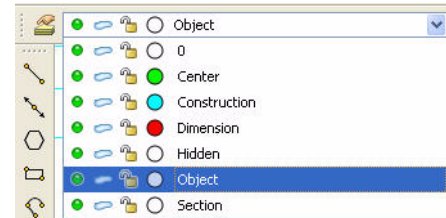

Click **Format, Line Weight** from the Main Menu.

The **Options** dialog box is displayed.



Check the **Display weight in graphics area** box.

Click **OK**

- 16 Save the Drawing.**

Click the **Save** icon  on the Standard toolbar.

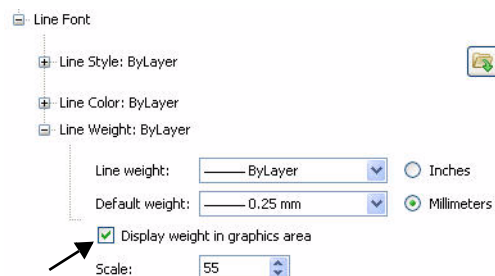

## Draw Three Profiles.

Utilize the **Line** command.

### 17 Draw the First Profile.

Click the **Line** icon  on the Draw toolbar

Options: Segments, *Enter to continue from last point* or  
Specify start point»**100,100**↵

Options: Segments, Undo, *Enter to exit* or  
Specify next point»**160,100**↵

Options: Segments, Undo, *Enter to exit* or  
Specify next point»**160,130**↵

Options: Segments, Undo, *Enter to exit* or  
Specify next point»**120,130**↵

Options: Segments, Undo, *Enter to exit* or  
Specify next point»**120,140**↵

Options: Segments, Undo, *Enter to exit* or  
Specify next point»**100,140**↵

Options: Segments, Undo, *Enter to exit* or  
Specify next point»**c**↵

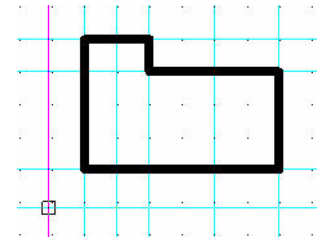
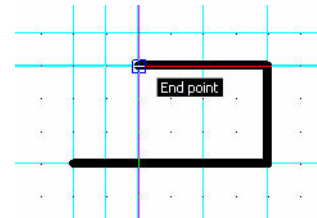

### 18 Draw the Second Profile.

Click the **Line** icon  on the Draw toolbar

Options: Segments, *Enter to continue from last point* or  
Specify start point»**190,100**↵

Options: Segments, Undo, *Enter to exit* or  
Specify next point»**220,100**↵

Options: Segments, Undo, *Enter to exit* or  
Specify next point»**220,140**↵

Options: Segments, Undo, *Enter to exit* or  
Specify next point»190,140 ↵

Options: Segments, Undo, *Enter to exit* or  
Specify next point»c ↵

Click the **Line** icon  on the Draw toolbar

Options: Segments, *Enter to continue from last point* or  
Specify start point»190,130 ↵

Options: Segments, Undo, *Enter to exit* or  
Specify next point»220,130 ↵  
Right-click **Enter**.

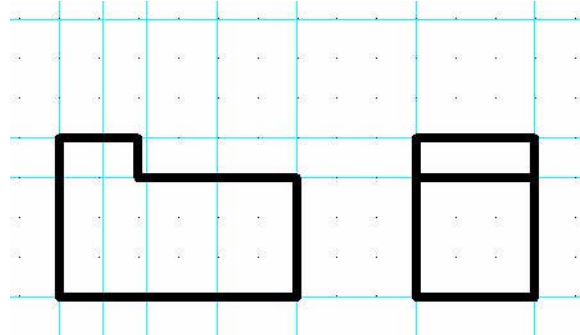

### 19 Draw the Third Profile.

Click the **Line** icon  on the Draw toolbar

Options: Segments, *Enter to continue from last point* or  
Specify start point»100,170 ↵

Options: Segments, Undo, *Enter to exit* or  
Specify next point»100,200 ↵

Options: Segments, Undo, *Enter to exit* or  
Specify next point»160,200 ↵

Options: Segments, Undo, *Enter to exit* or  
Specify next point»160,170 ↵

Options: Segments, Undo, *Enter to exit* or  
Specify next point»c ↵

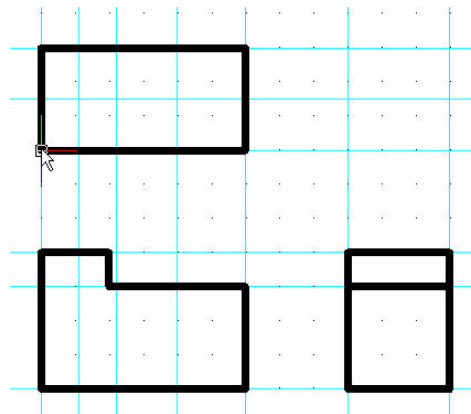

Click the **Line** icon  from the Draw toolbar

Options: Segments, *Enter to continue from last point* or  
Specify start point»120,170.↓

Options: Segments, Undo, *Enter to exit* or  
Specify next point»120,200.↓

Right-click **Enter**.

Click the **Circle** icon  on the Draw toolbar

Options: 3Poi nt, 2Poi nt, Itr, III, *Enter to exit* or

Specify Center point»140,185.↓

Options: Di ameter or

Specify Radius»5.↓

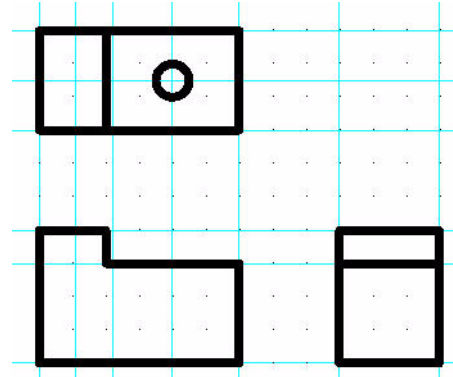

## 20 Save the Drawing.

Click the **Save** icon  on the Standard toolbar.

## 21 Activate the Hidden Layer.

Click **Hidden** from the drop-down menu in the **Layers Manager**.

## 22 Draw the First Set of Hidden Lines View.

Click the **Line** icon  on the Draw toolbar

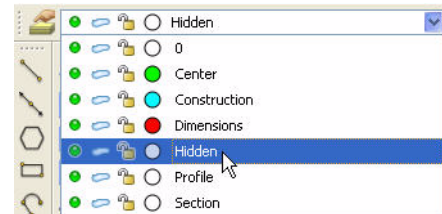

Options: Segments, *Enter to continue from last point* or  
Specify start point»135,100.↓

Options: Segments, Undo, *Enter to exit* or  
Specify next point»135,130.↓

Right-click **Enter**.

Click the **Line** icon  on the Draw toolbar

Options: Segments, *Enter to continue from last point* or

Specify start point»145,100.↓

Options: Segments, *Enter to continue from last point* or

Specify start point»145,130 ↓

Right-click **Enter**.

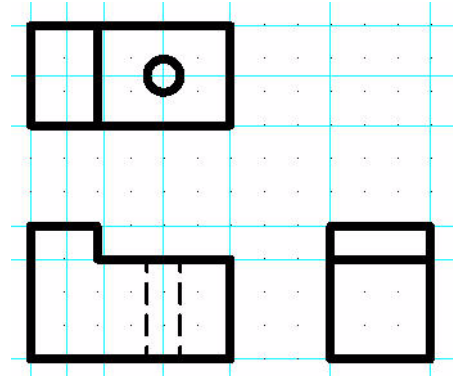

### 23 Draw the Second Set of Hidden Lines View.

Click the **Line** icon  on the Draw toolbar

Options: Segments, *Enter to continue from last point* or

Specify start point»200,100.↓

Options: Segments, Undo, *Enter to exit* or

Specify next point»200,130.↓

Right-click **Enter**.

Click the **Line** icon  on the Draw toolbar

Options: Segments, *Enter to continue from last point* or

Specify start point»210,100.↓

Options: Segments, Undo, *Enter to exit* or

Specify next point»210,130 ↓

Right-click **Enter**.

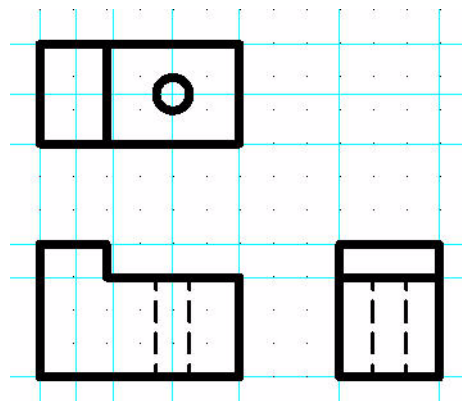

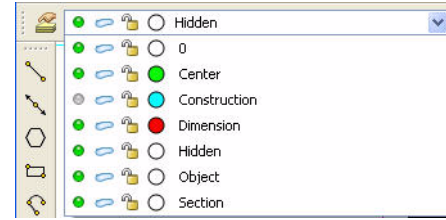

**24 Hide the Construction Layer.**

Click the **Show** icon  for the Construction layer from the drop-down menu in the **Layers Manager**.

**25 Activate the Section Layer.**

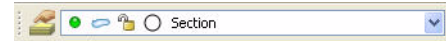
Click **Section** from the drop-down menu in the **Layers Manager**.

**Hatch Command**

Use the **Hatch**  command to fill enclosed areas or selected entities with a hatch pattern. Hatching a drawing adds meaning and helps to differentiate the materials and areas. Some drawing applications such as construction drawings require hatch patterns which can increase the clarity and legibility of a drawing

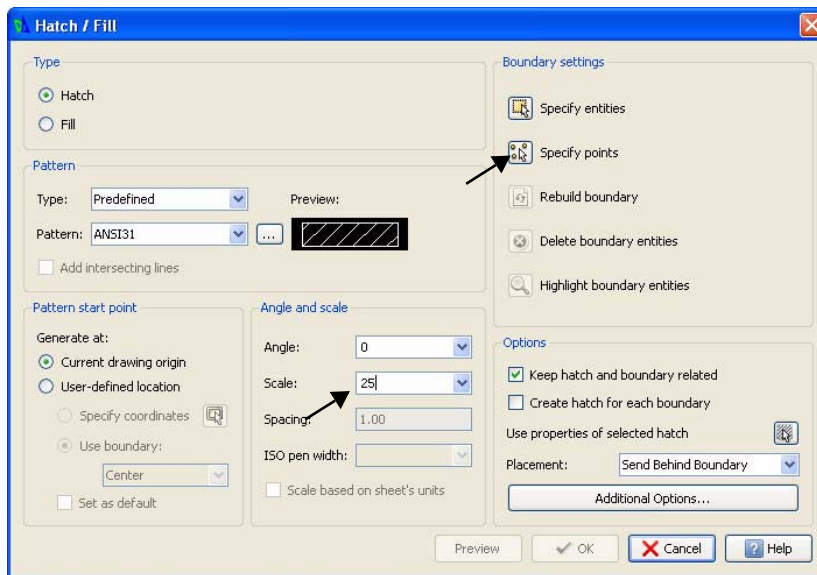
**26 Hatch the Front View.**

Click the **Hatch/Fill** icon  from the Draw toolbar.

**Angle and scale:**

**Scale:** Enter 25.

**Boundary settings:**

Click the **Specify points** button.

Options: Deselect boundary, Entities or



Specify internal point»

Click a Point to the right of the right Hidden Line as illustrated.

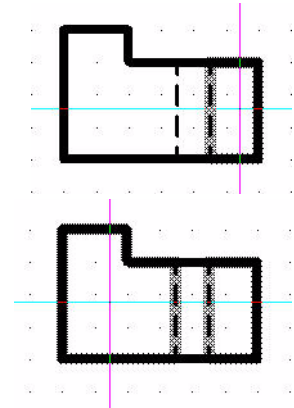

Click a Point to the left of the left Hidden Line. A boundary is created in both areas.

Options: Deselect boundary, Entities or  
Specify internal point»

Click **OK**.

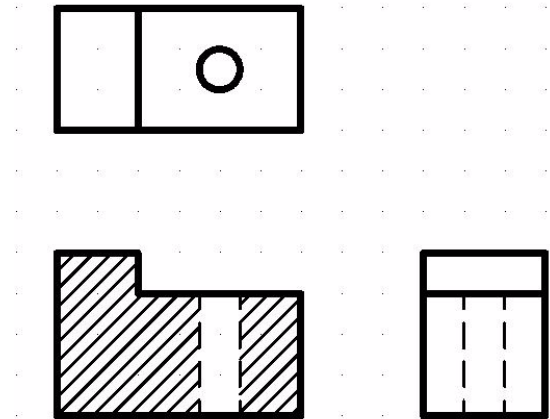

### NOTE:

In normal drafting practice, the Hidden Lines need to be converted to an Object Line for this section view. This is only an example of the command available.

## Dimension the Views

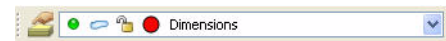

### 1 Activate the Dimension Layer.

Click **Dimension** from the drop-down menu in the **Layers Manager**.

The **DimensionStyle**  command from the Dimension toolbar provides the ability to create and modify DimensionStyles.

### 2 Set DimensionStyle

Click the **DimensionStyle** icon  on the Dimension toolbar.

The **DimensionStyles Manager** dialog box is displayed.

Expand **Fit, Dimension scale** in the **Navigation** box.

View the **Fit** options displayed on the right side of the dialog box.

**Scale factor:** Enter **25**.

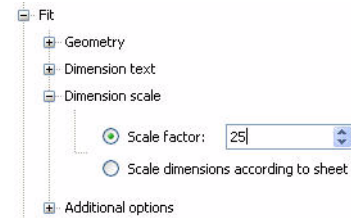

**3 Modify the Linear dimension Precision.**

Expand **Linear Dimensions** in the **Navigation** box.

**Precision:** Select **0** from the drop-down menu.

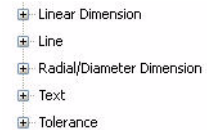

**4 Modify the Center Mark Display.**

Expand **Radial/Diameter Dimension, Center mark display** in the **Navigation** box.

**Size:** Enter **25.00**

Click **OK**.

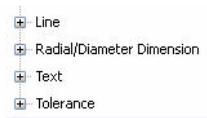

Dimension Commands

Linear Command

The **Linear**  command creates a horizontal, vertical, or rotated linear dimension.

One way to use the Linear command is to define two Points of measurement which are the origins of the Extension Lines.

The measurement is placed as Dimension text based on the definitions of the current DimensionStyle.

Create Linear Dimensions

Dimension the rectangle in the graphics area. Create a linear horizontal and linear vertical dimension.

**5 Dimension the Front View.**

Click the **Linear** icon  on the Dimension toolbar.

Default t: Entity

Options: Entity or

Specify first extension line position»

Click the lower left end point of the front view.

Specify second extension line position»

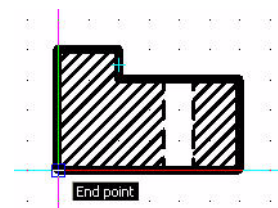

Click the lower right end point of the front view.

Options: Angle, Horizontal, Note, Rotated, Text, Vertical or

Specify dimension Line position»

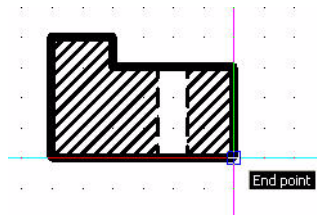

Click a position below the bottom Horizontal Line.

:

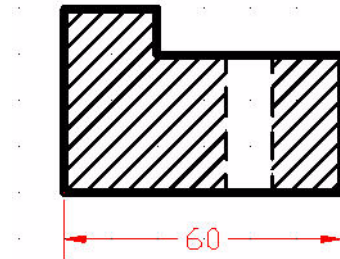

### NOTE:

The **Note** option provides the ability to modify the Dimension text using the Note editor dialog box.

### 6 Create a linear vertical dimension.

: ↓.

### TIP:

Press the **Enter** (↵) key to repeat the command.

Default: Entity

Options: Entity or

Specify first extension Line position»

Click the lower left end point of the front view.

Specify second extension Line position»

Click the upper left end point of the front view.

Options: Angle, Horizontal, Note, Rotated, Text, Vertical or

Specify dimension Line position»

Click a position to the left of the left Vertical Line. The front view has a vertical and horizontal linear dimension.

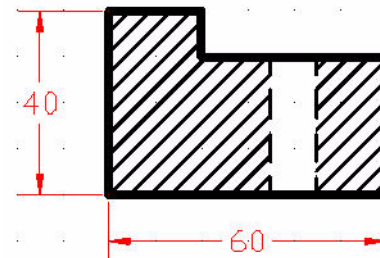

**TIP:**The **Angle** option changes the angle of the Dimension text.**7 Add Two Additional Dimensions.**

Add two additional Dimensions as illustrated.

The Front view is complete.

**8 Save the Drawing.**Click the **Save** icon  on the Standard toolbar.**9 Dimension the Top View.**Add **Linear** and **Diameter** Dimensions as illustrated.

Apply the Tolerance

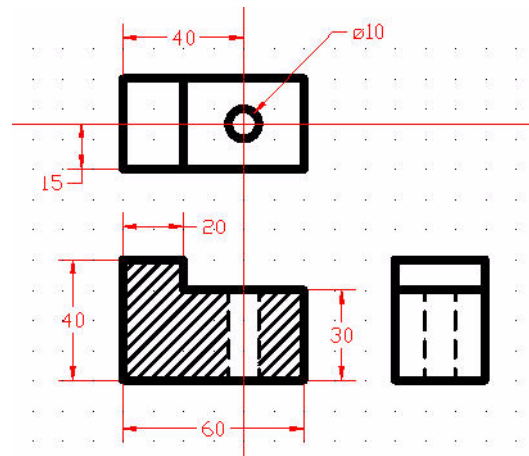
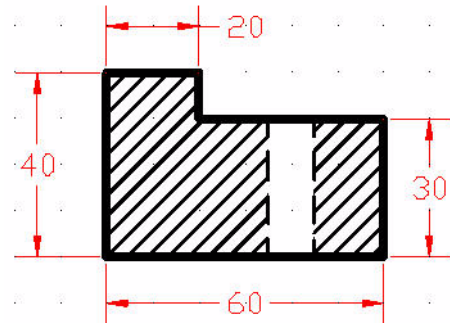
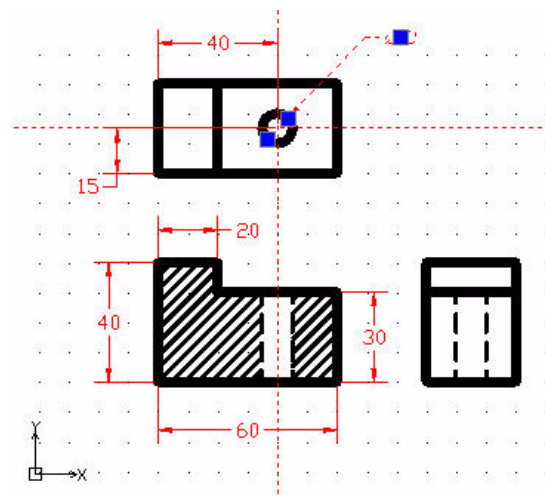
**10 Modify the Tolerance precision.**Click the **10mm** diameter Dimension.In the **Properties manager palette** scroll to the **Tolerance** section.

- Change the Tolerance display to **Limits**
- Change the **Upper limit** to 0.10
- Change the **Lower limit** to 0.20
- Set **suppress tolerance trailing zeros** to Yes
- Press **Esc** or **Enter** to exit.

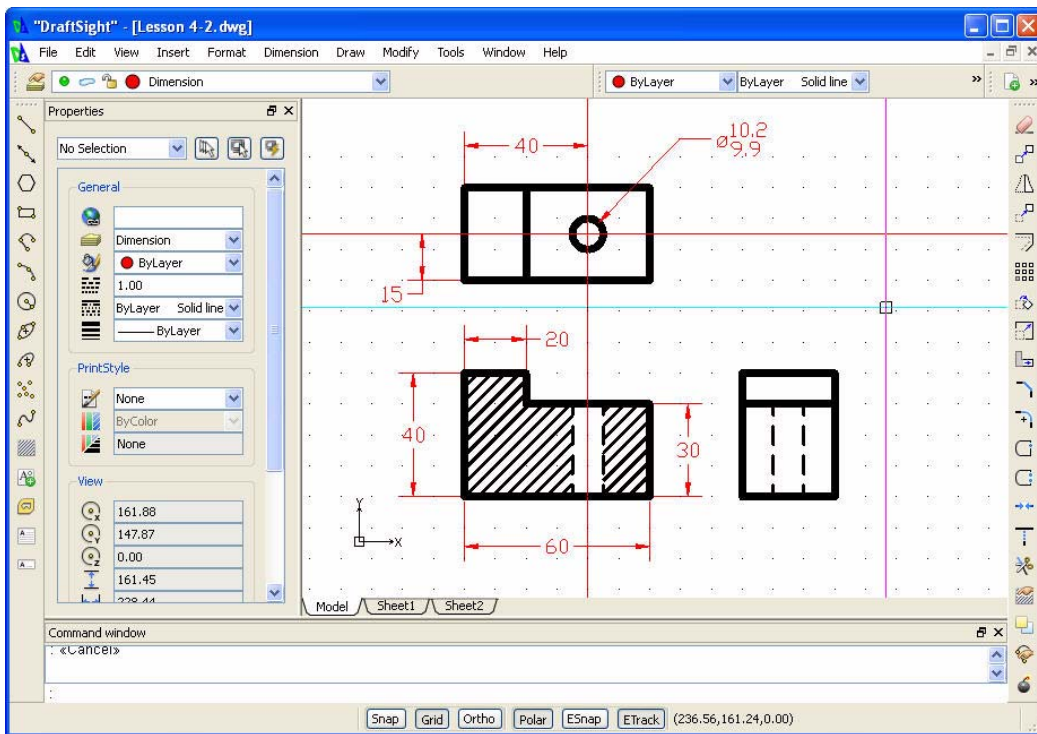
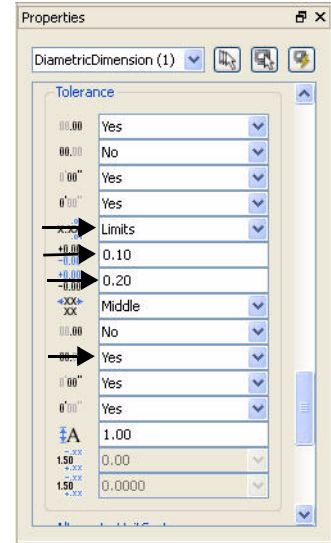

You are finished with this section.

